

# BIOSOLAR GREEN ROOF FINISH

## Example System Configurations

Bauder BioSOLAR is a revolutionary solar PV mounting system for biodiverse or extensive green roofs. Well suited to new build applications where environmentally friendly solutions are required to meet planning and BREEAM requirements. Our BioSOLAR system can also be retrofitted on many existing roofs without the need for any structural modification to the building.

A key element is that the front edge of the PV panel is set 300mm above the level of the substrate, which allows liberal growing room for the vegetation without blocking light to the array that would otherwise reduce the efficiency of the panels. This height setting also enables light and moisture to reach beneath the panel to support the plants below.

See Chapter 11 for more indepth information

### Vegetation Mats

Bauder's SB substrate sedum blanket or WB native wildflower blanket can be used to stabilise the substrate quickly in exposed locations and gives instant greening between panels. These are typically placed between rows only (not under the panels) with Bauder Flora 3 seed mix being used in these shadier areas.

### Plug Planting

Plug plants are used in areas where particular species are required. Care is required to only specify species that do not grow higher than the panels.



### Bauder Flora 3 Seed Mix

The Flora 3 seed mix has been specially designed to work with the Bauder BioSOLAR system and is a mix of low growing and shade tolerant species. The whole roof area can be of benefit to wildlife, taking advantage of the mixture of shade sun and shelter the BioSOLAR roof offers.

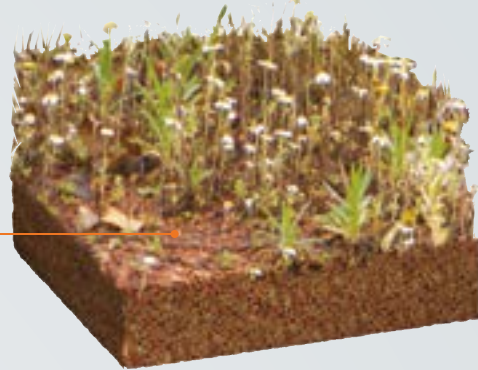

Seed Mix

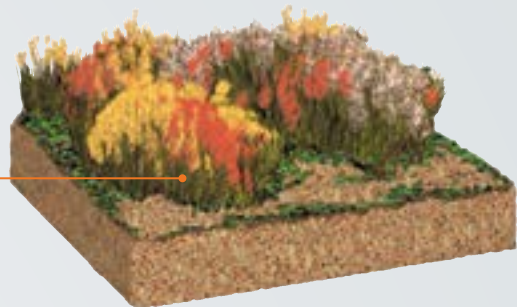

Plug Plants



Vegetation Mat

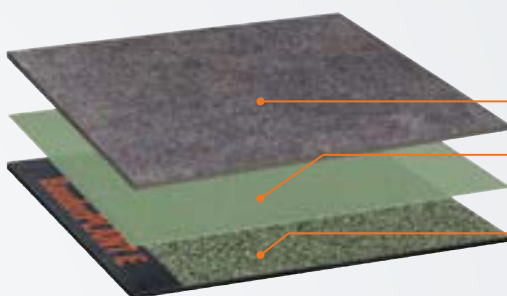

### Bauder FSM600 Protection Mat

recycled polyester and polypropylene fibre mix.

### Bauder PE Foil

polyethylene foil separation and slip layer manufactured from recycled granules.

### Bauder Waterproofing

shown here with Plant E root resistant, SBS modified bitumen membrane reinforced with 250g/m<sup>2</sup> recycled spunbond polyester.



[www.bauder.co.uk/technical-centre](http://www.bauder.co.uk/technical-centre)

## SYSTEM SUMMARY

## BauderSOLAR G LIGHT

### Green roof mounting solution for framed solar photovoltaic modules

BauderSOLAR G LIGHT is an integrated solar PV mounting system specifically for Bauder biodiverse or extensive green roofs.

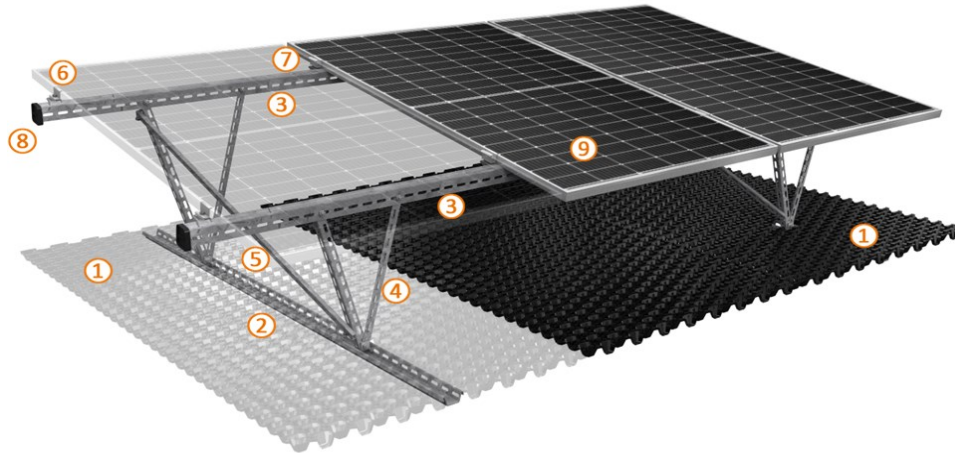

Product	Description	Dimensions (mm)	Weight
<b>1 BauderSOLAR DSE 40</b> Anchor board	Modified DSE40 drainage board installed above base rails to ballast the mounting system	1040 x 2030	
<b>2 BauderSOLAR BS-4</b> or <b>BauderSOLAR BS-2</b> Base Rail	Powder coated steel base rail installed on protection layer and beneath DSE40 Anchor board	3994 (BS-4) or 1994 (BS-2) x 36 x 72	
<b>3 BauderSOLAR MTR</b> Module carrier rail	Powder coated steel profile rail to support framed solar modules	4700 x 61.9 x 47.5	
<b>4 BauderSOLAR VT 745</b> <b>BauderSOLAR VT 545</b> V-beams	Pre-assembled V-shaped module carrier rail support manufactured from powder coated steel	L 745 x 399 x 54 S 545 x 343 x 54	
<b>5 BauderSOLAR DLE</b> Diagonal profile	Support rail to add rigidity to mounting system—Powder coated steel	1245 x 30 x 15	
<b>6 &amp; 7 BauderSOLAR MKL (mid) or</b> <b>BauderSOLAR EKL (End)</b>	Mid and end pre-assembled module clamps	n/a	
<b>8</b> Module rail end cap	Polypropylene end cap to protect module mounting rail ends	n/a	
<b>9</b> Solar module	Framed crystalline solar photovoltaic module	Variable	
<b>Total system weight (kg/m<sup>2</sup>)*</b>			<b>176kg/m<sup>2</sup></b>

\*Includes weight of Bauder BTRS roof system with 160mm PIR insulation and saturated Biodiverse green roof based on a substrate depth of 100mm

## SYSTEM OPTIONS

Solar module options**		
Module	Efficiency	Size
JAM60S-20-385-MR	20.7%	1052mm x 1769mm
LG Neon H—380Wp	20.4%	1016mm x 1700mm

### Recommended planting mix:

Name	Description
<b>Bauder Flora 3 Seed Mix GB50120403</b>	A broad mix of low growing and some shade tolerant species ideal, for most roof environments. Recommend for BioSOLAR installations.

\*\*Bauder BioSolar is a universal mounting system. The listed modules are for reference only, please contact Bauder for advise on project specific module selection.

### UNITED KINGDOM

Bauder Ltd  
70 Landseer Road, Ipswich, Suffolk IP3 0DH  
T: +44 (0)1473 257671 E: info@bauder.co.uk  
[bauder.co.uk](http://bauder.co.uk)

### IRELAND

Bauder Ltd  
O'Duffy Centre, Carrickmacross, Co. Monaghan  
T: +353 (0)42 9692 333 E: info@bauder.ie  
[bauder.ie](http://bauder.ie)

# BAUDER

## Solar PV Solutions



Our photovoltaic solutions are innovative, penetration-free systems for use in flat, green and blue roof applications.

Both our systems are extremely quick to install and provide a cost effective and highly efficient solution.

■ Overview	238
■ Credentials	240
■ BauderSOLAR	242
■ Bauder BioSOLAR	248
■ Waterproofing Options	254
■ Technical Data	255



# OVERVIEW OF SOLAR PV



**UWE ENTERPRISE ZONE**

Location: **Bristol**

*"The system we chose means the panels are welded into place, reducing load, and the need for roof penetrations and thereby risk of leaks. The University will use 100% of the power generated, equal to the amount of nearly 200 homes with solar panels. As a large organisation we want to set an example for others to undertake similar projects."*

**Fabia Jeddere-Fisher, Energy Engineer, UWE**



Our photovoltaic solutions are specifically designed to deliver the most efficient energy generation solution on flat and green roofs. Our systems are designed to ensure the waterproofing system beneath remains completely intact and without compromise, which can occur when mechanical fixing methods are used that penetrate the roof.

The entire installation process of both of our photovoltaic systems is quick and simple and only our approved contractors, engineers and installers are fully trained and certified to install our unified rooftop solutions.

Through our systems we guarantee the entire specified roof package rather than a separate element, giving single source point of contact and responsibility to reduce risk.

We have two systems within our photovoltaic portfolio:

### BauderSOLAR for Flat Roofs

Our BauderSOLAR flat roof PV solution is suitable for new build and retrofit projects and features a mounting system that is secured to the roof using membrane-to-membrane welding techniques on our bituminous or single ply waterproofing.

The modules are positioned at a 12° angle to maximise energy generation and can be installed in both south facing and east/west orientations pending on site requirements.

### Bauder BioSOLAR for Green and Blue Roofs with Vegetation

Bauder BioSOLAR is a unified solution for mounting solar PV arrays where the substrate and vegetation provide the ballast to secure the array.

The combination of systems and the height at which the panels are positioned allow for vegetation to establish across the entire roof area helping the building achieve enhanced BREEAM ratings and meet planning targets for both the green roof and solar PV requirements.

### PV Partners – Assuring Quality

We provide the ultimate solution for our clients through our partnerships with JA Solar and LG as we trust their uncompromising quality standards to ensure that every module produced delivers the same quality output and high efficiency.

It is all too common that performance and quality can frequently vary dramatically between/amongst manufacturers, even if the same cells are used and the modules appear to be similar; and so it becomes increasingly apparent that the superiority and reliability of the manufacturer is far more important than selecting modules by output statements alone.

Our ethos is to work so that every Bauder installation is as good as the next.

#### Specification Support



#### Specification downloads:

[www.bauder.co.uk/technical-centre](http://www.bauder.co.uk/technical-centre)



#### Telephone helpline:

0845 271 8800





# ENVIRONMENTAL CREDENTIALS



Our Solar PV roofs have the potential to count towards BREEAM. If you are working to this assessment standard, please contact a member of our technical team, who can advise on best practice for your individual project.

## Energy

This category encourages the specification and design of energy efficient building solutions towards sustainable use and management throughout the operation of the building's life.

### Ene 01 - Reduction of energy use and carbon emissions

Any low or zero carbon technologies installed can be used to offset emissions arising from regulated and unregulated (for exemplary credits) energy consumption. The requirement details for a private wire arrangement to be in place, i.e. no grid sustainable energy purchase.

**BauderSOLAR PV and Bauder BioSOLAR photovoltaic solutions** create local energy generation from renewable sources. They are specifically designed to deliver the most efficient energy generation solution on flat and green roofs where the installation method ensures the waterproofing beneath remains completely intact and without compromise.

### Aiding Biodiversity and Meeting a Biodiversity Action Plan (BAP)

Our BioSOLAR roof can provide a natural habitat for the local ecology, in which vegetation will establish and provide a home for smaller elements of wildlife as well as insects and invertebrates. The provision of a healthy habitat in a place that could otherwise be empty encourages wildlife to remain in the area, provides support for the natural colonisation of locally arising plants, birds and small animals, boosting a wider spread of species in the area.

### Recycling, End-of-Life and Upcycling of Our Products

In Europe, solar panel disposal falls under the European Union's Waste of Electrical and Electronic Equipment (WEEE) directive and is strictly regulated.

### BauderSOLAR

The individual components of our BauderSOLAR Flat Roof system are single-origin and can be individually removed and completely recycled. The main support structure and locking pin are made from plastic category 05 Polypropylene and is widely recycled; with the base plate, bayonet fitting and module clamp all from plastic category 07 Polyamide which is recycled into plastic lumber and other custom-made products.

### Bauder BioSOLAR

The DSE40 anchor boards for our BioSOLAR system are made from polypropylene which is widely recycled.

The support system for our Bauder BioSOLAR system is made from coated steel; the arms, support rails and clamps can be recycled through melting down and reforming the metal without losing quality.



# TECHNICAL CREDENTIALS

## Regulations, Guidelines and Standards

Our products are built in accordance with applicable standards and technical regulations and therefore correspond to all relevant technical standards. This applies to both material selection and structural design.

BSEN 62446 Grid Connected Photovoltaics  
BSEN 61853-1 Defining Solar Photovoltaic Power  
BSEN 1991-1-4 Wind Actions on Structures  
BRE Digest DG 489 rev 20145

The aluminium alloy framed modules are certified through VDE (IEC 61215 Ed. 2, IEC 61730-1 Ed.1 and IEC 61730-2 Ed. 1)

## Array Designs

Bauder PV array proposals are designed to meet MCS PV Guide requirements and IET Codes of Practice.

## Maximising the Roof Area

Our photovoltaic solutions are designed to allow for the maximum number of modules to be installed on the roof area for both east-west or south orientations. This gives prime energy generation from the roof compared to standard 30° fixed tilt solutions.

## Bauder Biosolar Module Section - Cross Section

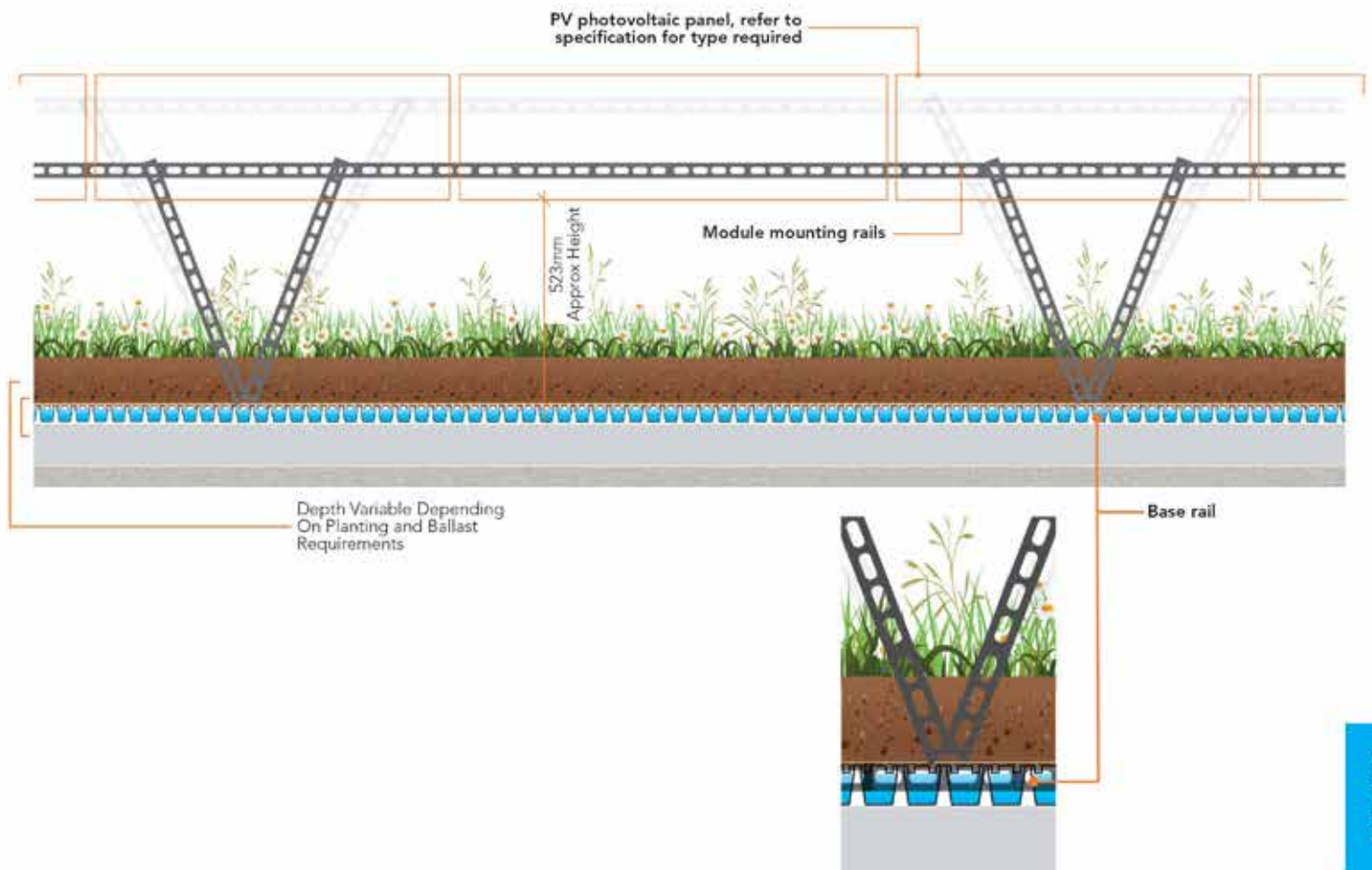

## Assuring Quality of PV Panels

It is all too common that performance and quality can vary dramatically between manufacturers, even if the same cells are used and the modules appear to be similar; and so it becomes increasingly apparent that the reliability of the manufacturer is far more important than selecting modules by output statements alone.

The superior manufacturing and quality testing of the JA Solar and LG modules ensure that quality output and high efficiency is standardised on all our installations.

## Increasing Efficiency

The BioSOLAR system has the advantage of increasing the efficiency of the solar array because the vegetation preserves ambient rooftop temperatures, keeping the PV modules at optimal output and increasing energy yields by 5% - 7%.





# BAUDERSOLAR FOR FLAT ROOFS



Image courtesy of  
Ivan Moore  
Lambert Smith Hampton

## 11 FREEBOURNES ROAD

Location: **Witham**

*"We actively look for opportunities to implement renewable energy and knew that this storage facility lent itself well to PV retrofit. Our system selection process involved the due diligence you would expect from a local authority and we decided to go with Bauder because of its comprehensive system portfolio that meant we could have a single source supply and all-inclusive guarantee; giving us complete confidence in the roof's performance."*

**Julian Sanchez, Commissioning Delivery Manager for Essex County Council**



11 Freebournes Road was a large derelict warehouse located in Witham, that underwent major renovation to transform it into a storage centre for Essex County Council. The roof was waterproofed with over 5,200m<sup>2</sup> of Bauder's reinforced bitumen system and then fitted with 588 solar PV modules enabling the client to generate at least 134.70 Megawatt Hours of solar power each year.



Image courtesy of Essex County Council



Our flat roof solar PV solution is an aerodynamically optimised system for framed modules suitable for both new build and retrofit projects. The mounting units are secured to the roof using membrane-to-membrane welding techniques on our bituminous or single ply waterproofing systems. This installation method means that the roof is not compromised by penetrations for fixings nor is it ballasted, which would add significant weight loading to the roof.

### Key Features

- Risk-free installation due to penetration free fixing methods to the flat roof waterproofing.
- Tool free installation of modules is quick and simple.
- High output to roof space ratio.
- Range of PV modules available to suit client needs and budget.
- Lightweight system 9-12.5Kg/m<sup>2</sup>, depending on the module selected.
- Aerodynamic to reduce the impact of wind uplift.
- Low profile with modules set at 12°, which can overcome some planning challenges.
- Single source for complete design of waterproofing and PV array with clear accountability.

Our combined solar array and waterproofing offer provides a single-source solution with clear accountability to reduce risk and bring peace of mind through all aspects of the flat roof.

The BauderSOLAR solution utilises high efficiency JA Solar and LG modules with a range of panel options to suit client needs and budget.

### Specification Support



**Specification downloads:**  
[www.bauder.co.uk/technical-centre](http://www.bauder.co.uk/technical-centre)



**Telephone helpline:**  
0845 271 8800

# BAUDERSOLAR

Risk free installation

BauderSOLAR delivers a technically advanced solution through design of the mounting system and manufacture and efficiency of the PV modules.

The entire installation is designed to embrace our ethos that you should not and do not need to use penetrative fixings or heavy ballast loads to mount a PV array as this could compromise the integrity of the waterproofing and roof deck.

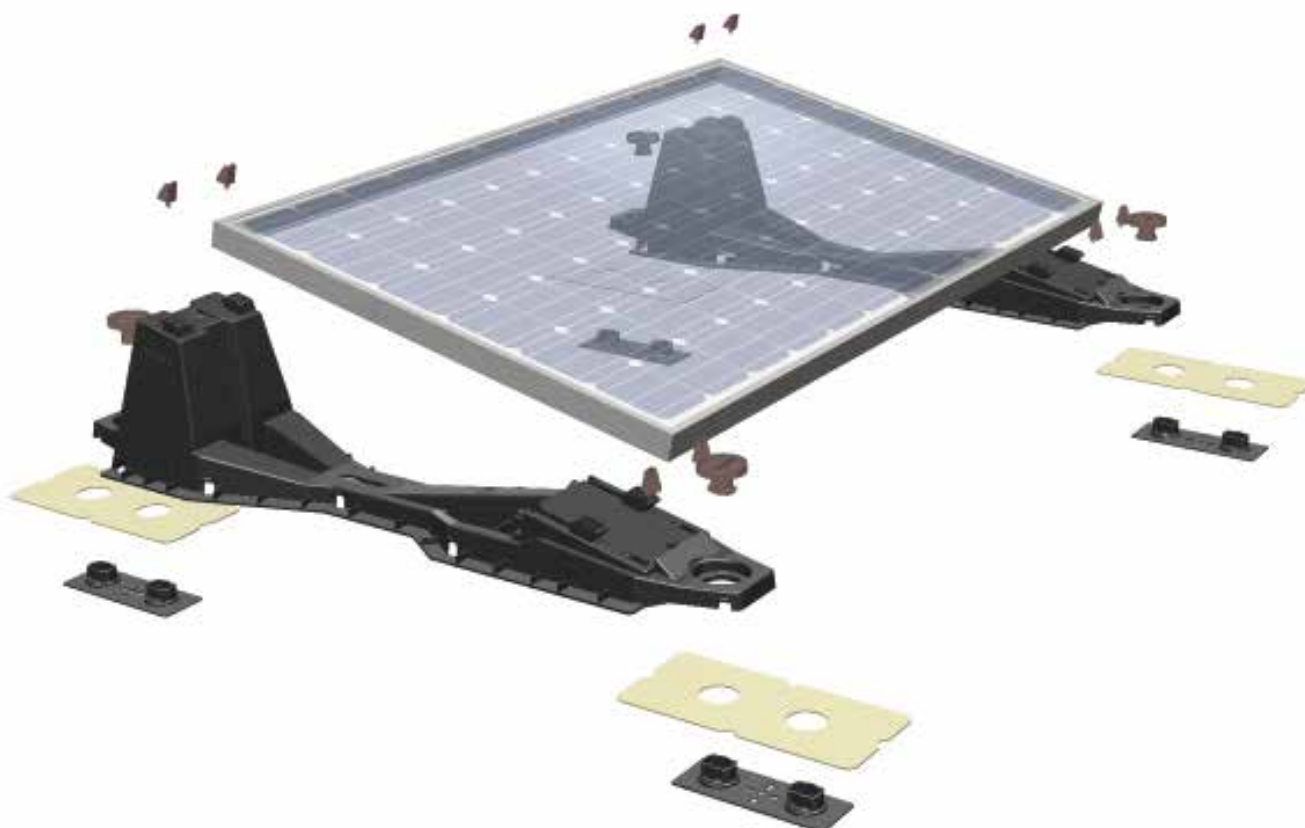



The distinctive element of our lightweight PV mounting system is the prefabricated Bauder membrane sleeves which slip over the mounting plates and are welded into position, anchoring the plates to the surface of the Bauder waterproofing system. Once this is completed, the rest of the PV installation is simply locked into place without any requirement for tools or sharp fixings.

The attachment of the mounting components is very stable so that even in extreme weather the entire array is secure on the roof. Any minor movement of the panels, which is generally created by wind uplift, is easily tolerated and does not affect the fixings, or waterproofing system.

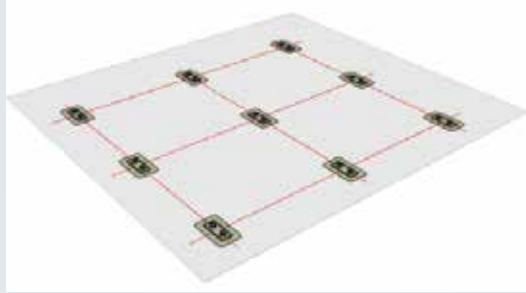

### 1. Positioning the Baseplates

The baseplates are plotted and measured out to ensure correct positioning according to the array design.

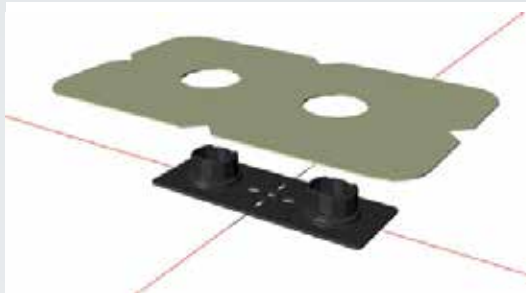

### 2. Attaching to Roof Surface

The waterproofing membrane sleeves are placed over each of the baseplates and welded into position.

The large attachment footprint is very stable and the entire array is secure on the roof even in extreme weather.



### 3. Installing the Mounting Units

The substructures are positioned over the mounting plates and locked into place.

The distance between the module rows is always 1450mm due to the fixed length of the substructures.



### 4. Placement of the PV Modules

The PV modules are placed onto the substructure mounting system and mechanically secured using a tool free fixing method.

Finally the cable support system and electrical connections conclude the installation.

# PROJECT STUDIES

BauderSOLAR



The University of the West of England (UWE) quadrupled its solar generating capacity through the installation of 1,731 solar panels, enabling it to produce over 400 MWh of electricity each year and making it the largest solar panel array in the UK university sector.

The solar array was installed on the roof of the University Enterprise Zone and the Bristol Robotics Laboratory, which both underwent extensive refurbishment as part of the required works. Prior to the PV being installed, approved contractor Mitie Tilley Roofing overlaid the original single ply waterproofing with over 12,000m<sup>2</sup> of Bauder's lightweight, robust PVC single ply waterproofing system Thermofol. The solar modules, which weigh less than 12Kg/m<sup>2</sup>, were then fitted using a unique penetration-free method by renewable energy specialists Dulas.

The PV system should generate enough electricity each year to; cover half of the energy usage within the building, save around 200 tonnes of carbon and provide annual savings of over £50,000 a year. The university is committed to sustainability and this project is just part of a much wider plan to achieve its carbon reduction goals.

*"The system we chose means the panels are welded into place, reducing load, and the need for roof penetrations and thereby risk of leaks. The University will use 100% of the power generated, equal to the amount of nearly 200 homes with solar panels. As a large organisation we want to set an example for others to undertake similar projects."*

**Fabia Jeddere-Fisher, Energy Engineer UWE**

## BUILDING BOARD

Project:	<b>UWE Enterprise Zone</b>
Location:	<b>Bristol</b>
PV Roof Area:	<b>12,000m<sup>2</sup></b>
Client:	<b>University of the West of England</b>
Main Contractor:	<b>BAM Construction</b>
Specifier:	<b>Parsons Brinckerhoff</b>
Approved Contractor:	<b>Mitie Tilley Roofing</b>
PV Installer:	<b>Dulas</b>

## APPLIED PRODUCTS

- 1,713 BauderSOLAR PV modules were fitted generating at least 402 Megawatt Hours of solar power each year.





Sheringham High School

Sheringham High School is a secondary school located in Norfolk that underwent significant refurbishment to repair a number of its failing roofs. The client wanted the school's campus to act as a benchmark for sustainability with the addition of solar panels.

Working closely with the surveyor PCH Associates, Bauder performed a comprehensive roof evaluation survey to identify the full extent of water ingress being experienced and to confirm the suitability of adding solar.

The school had 150 BauderSOLAR PV modules fitted by electrical Joju Solar. As a result the school will be able to generate at least 34.61 Megawatt Hours of power each year, all without any capital expenditure or any disruptions to the school term. Funding for the solar PV array was provided through a community share offer. The Schools' Energy Co-operative, ensuring both the school and the local community benefited financially from the solar installation whilst also providing clean renewable energy.

BUILDING BOARD	
Project:	<b>Sheringham High School</b>
Location:	<b>Sheringham, Norfolk</b>
PV Roof Area:	<b>1,500m<sup>2</sup></b>
Surveyor:	<b>PCH Associates</b>
Approved Contractor:	<b>R T Roofing</b>
PV Installer:	<b>Joju Solar</b>
Fundraising Specialist:	<b>Energy4All</b>

APPLIED PRODUCTS	
<ul style="list-style-type: none"> <li>• Bauder Total Roof System with 35yrs BBA certified life expectancy.</li> <li>• 150 BauderSOLAR PV modules were fitted, achieving a kilowatt peak of 39.00.</li> </ul>	

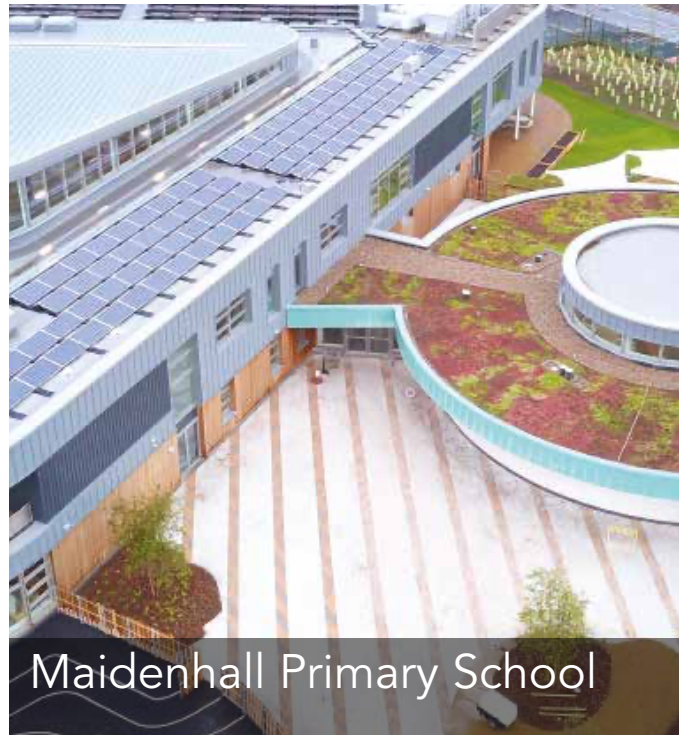

Maidenhall Primary School

The completely new Maidenhall Primary School on a fresh site in East Renfrewshire, near Glasgow was designed to create an educational space for pupils and staff that was secure, stimulating and suitable. Bauder helped them to achieve this by fulfilling roofs that incorporated seven different systems completed on time and on budget.

- Bauder single ply with PIR tapered insulation and acoustic insulation
- BauderSOLAR PV
- Bauder Total Roof System with vacuum insulation and PIR insulation
- Bauder Total Green Roof System
- Bauder XF301 Sedum System

In total, almost 3,000m<sup>2</sup> of flat roof waterproofing systems, green roofs and solar PV were supplied by Bauder and installed by its Approved Contractor, Procladd Ltd so that a comprehensive guarantee could be issued encompassing products and workmanship to give complete peace of mind to the client for years to come.

BUILDING BOARD	
Project:	<b>Maidenhall Primary School</b>
Location:	<b>Glasgow</b>
Client:	<b>BDP</b>
Main Contractor:	<b>BAM Construction</b>
Approved Contractor:	<b>Procladd Ltd</b>



# BAUDER BIOSOLAR FOR GREEN



## NATIONAL INNOVATION CENTRE FOR DATA

Location: **Newcastle upon Tyne**

*"Working with Bauder makes life so much easier because we can really tap into their expertise. The Bauder BioSOLAR PV system is a straightforward and quick system to install, incorporate that with Bauder excellent support team made the Newcastle NICAD installation was a dream to work on, and most importantly it looks great."*

**Andrew Connell, Project Manager, Energize Electrical Services Ltd**



# AND BLUE ROOFS

This flagship building in the city centre Helix Science site is topped with a high-tech roof combining solar PV with a biodiverse green roof and wildflower plants using our BioSOLAR solution. The 30.78kWp system, generates an estimated 26,140kWh per annum.



Our BioSOLAR is an integrated solution for mounting photovoltaic renewable energy on a green roof or a blue roof where the substrate and vegetation provide the ballasted installation mechanism to secure the array. The system is suitable for both new build construction and retrofit projects.

This system allows for the entire roof area to qualify as a green roof, and if a biodiversity vegetation finish is elected for, this can further enhance the BREEAM credit rating for the roof element.

## Key Features

- No roof penetrations as substrate and vegetation ballast the PV array.
- Maximises solar output and allows entire roof to qualify as biodiverse green roof.
- Maximises solar energy generation as green roof preserves ambient rooftop temperatures, keeping the modules at optimal output. The cooling effect increases panel output by up to 5%.
- Raised modules allow light and moisture under the panels and the creation of a variety of habitats supporting a greater range of plant species and small invertebrates.
- Single point responsibility for the waterproofing, green roof and PV installation.
- Increased module space between substrate and panels reduce risk of panel damage during green roof maintenance.

## Varied Habitats for Flora and Fauna

The panels create a mixture of sunny, shaded and sheltered areas and together with a variable depth of FLL compliant extensive substrate the roof gives a matrix of different habitats, which allow a broader range of plant species to thrive, and small invertebrates to seek refuge from strong wind and rain. Additionally undulations in substrate can be created to enrich the rooftop growing conditions for an even broader mix of flowering vegetation, providing a rich foraging environment for bees and insects. (See page 186 for vegetation options)

## Symbiotic Relationship

A key element of the BioSOLAR system is that the front edge of the PV panel is set at around 300mm above the level of the substrate, which allows liberal growing room for the extensive vegetation without blocking light to the crystalline solar cells that would otherwise reduce the efficiency of the modules. This height setting also enables light and moisture to reach beneath the panel to support the plants below and allows for maintenance of the green roof.

### Specification Support



#### Specification downloads:

[www.bauder.co.uk/technical-centre](http://www.bauder.co.uk/technical-centre)



#### Telephone helpline:

0845 271 8800



# BIOSOLAR

Safe guarded installation

## Optimising the Combined Technologies

In the Bauder BioSOLAR solution, the solar modules are raised above the substrate and angled at 10° to optimise the capacity for solar energy production and green roof area so that both can easily occupy the same space and work in synergy. In alternative systems the technologies compete against each other for roof space, with one conceding to the other.

The PV panels are set at around 300mm above the level of substrate so that the growth of the vegetation does not reduce the efficiency of the panels through shading and allows for maintenance of the green roof. The height also lets sufficient levels of moisture and light infiltrate beneath the modules, supporting different species of plants and enhancing the biodiversity of the roof.

## Improved Solar Panel Efficiency

A combined green roof with PV delivers advantages to the building as the cooling effect of the vegetation and water held within the green roof system preserves a cooler ambient temperature around the photovoltaic array. Studies in Germany have shown that PVs work most efficiently with an ambient temperature of around 24°C and that when an array is combined with a green roof, the panels are expected to achieve around a 5-7% higher output compared to an installation on membrane alone.



## Bauder Biosolar Module Section - Cross Section

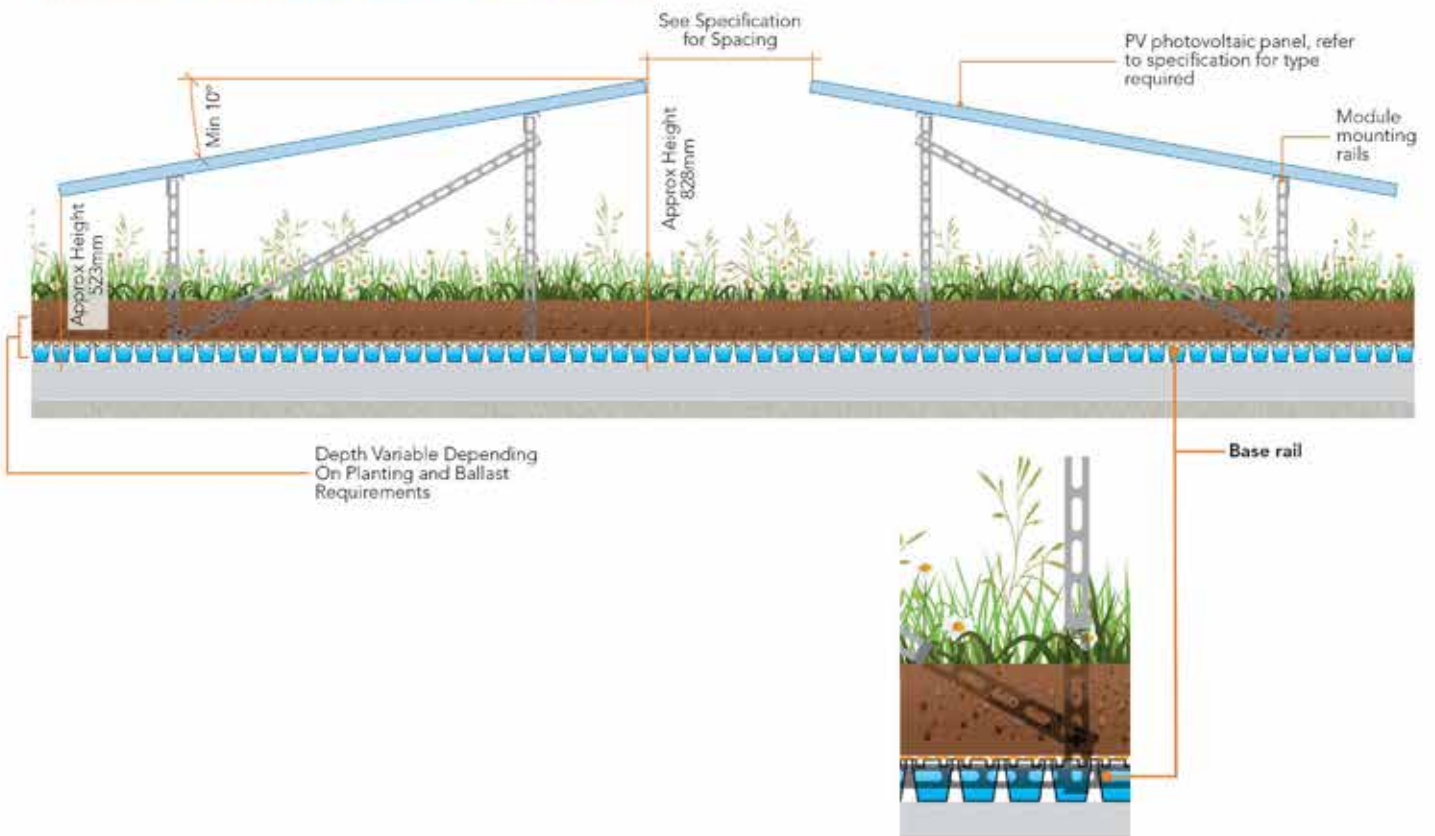



The mounting board is a bespoke moulded landscaping component manufactured from polypropylene with a deep recessed profile that provides water storage and multidirectional drainage whilst also providing a repository for the green roof substrate. A support profile is formed in the centre of the board to which the mounting arms are attached.

The boards are positioned on the top of separation and protection layers which prevent mechanical damage to the waterproofing.

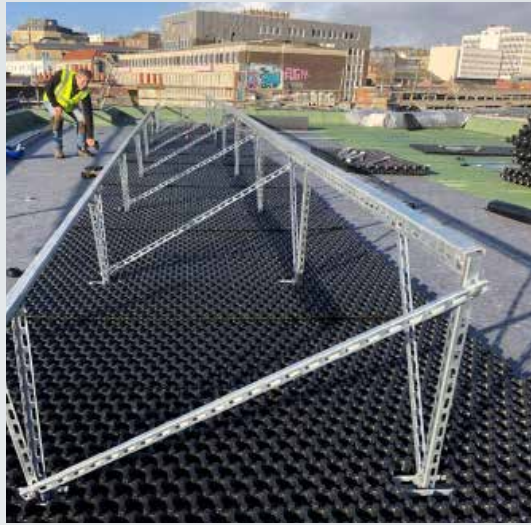

### 1. Positioning the DSE40 Anchor Board and Attaching the Railing System

The DSE40 anchor boards are positioned according to the array design with any areas between the boards or around the perimeter finished using our DSE 40 board. The Coated Steel BioSolar mounting system is then fixed to base rails beneath the anchor boards.



### 2. Installing the Substrate

The substrate is poured into the mounting board to ballast the array.



### 3. Placement of the PV Modules

The PV panels are secured to the carrier rails with clamps.



### 4. Seeding the Vegetation

The Bauder Flora 3 seed mix is broadcast onto the pre-watered substrate so that the seeds can germinate and grow.

(See page 186 for vegetation options)



# PROJECT STUDY



Clapham Park



The regeneration at Clapham Park involved the demolition of old housing stock to make way for new affordable homes. The 5-storey building with 21 dwellings incorporating the latest rooftop technology which blends a biodiverse green roof and unified solar PV array. This approach met the planning requirements and maximised the limited roof space to generate energy for the residents. The development was certified BREEAM 'Outstanding' due to its environmental, economic and social sustainability attributes.

One of the major challenges of the project was the roof and a renewable energy system to meet the main objectives of sustainability and energy efficiency of the development highlighted by the planning committee. The roof contributed towards requirements under National Planning Policy Framework (NPPF) Chapter 11: Conserving and enhancing the natural environment and The London Plan 2011 Policy 5.2 - Minimising Carbon Dioxide Emissions, Policy 5.3 - Sustainable Design and Construction and Policy 5.7 - Renewable Energy. The green roof is layered with a raised PV array so that the entire roof qualifies as a green roof whilst also providing energy generation.

The Bauder BioSOLAR system has National House Building Control (NHBC) approval and meets local authority building control (LABC) requirements. The system was installed on zero falls roof deck, making it a very cost-effective solution.

The biodiverse green roof which includes 35 plant species recognised by the RHS as Perfect for Pollinators, covers the totality of the roof area and offers a large variety of vegetation. The building reduces its carbon impact with the highly efficient PIR insulation and generates approximately 10% of the flats usage with a maximum possible output of 75kWp from the 70 PV modules. The solar PV mounting units are ballasted by the substrate and vegetation, removing the need for any penetrating products in the waterproofing.

## BUILDING BOARD

Project:	<b>Clapham Park</b>
Location:	<b>Clapham Park, Lambeth, London</b>
PV Roof Area:	<b>500m<sup>2</sup> green roof layered with 116m<sup>2</sup> of PV</b>
Specifier:	<b>PJMA Architects</b>
Approved Contractor:	<b>EJ Roberts Ltd</b>
PV Installer:	<b>M &amp; M Electrical Ltd</b>

## APPLIED PRODUCTS

- Bauder Total Green Roof System is a premier bituminous waterproofing with a life expectancy of over 40 years.
- Bauder BioSOLAR integrates a green roof and photovoltaics into one system drawing the maximum potential from a flat roof.
- Flora 3 Seed Mix is a blend of 49 British native species seed, to maximise diversity of vegetation on green roofs.





### BioSOLAR Vegetation

The Bauder Flora 3 Seed Mix is a blend of seed, tackifier and additives developed to maximise diversity of vegetation on green roofs. Bauder Flora 3 has all the components required to improve the germination and the successful establishment of vegetation for a variety of rooftop conditions: light and shade; exposed and sheltered. The varied mix of species is designed to deliver the British native, biodiverse species required for BREEAM compliance.

Bauder Flora 3 contains a broad range of wildflowers chosen to give an extended flowering season providing nectar and pollen rich habitat for priority pollinators, larval food plants for butterflies and seed sources for birds.

Typically the mix will produce flowers from April to October starting with species Wild Strawberry and Cowslip, through the summer with Yarrow and Black Knapweed with Lady's Bedstraw flowering later into the autumn. The annuals, biennials and grasses will provide cover and colour in the first season allowing time for the slower growing perennials to establish in later years. The mix has been specified to be drought tolerant with sedum species and low growing perennials. Plants are chosen that do not exceed 40cm in height to avoid problems with shading of solar panels when the vegetation is used in conjunction with Bauder BioSOLAR. Shade tolerant ground cover plants were specified that will occupy semi-shade microclimates under the panels.

The seed source is British Provenance (with the exception of sedum species) and suppliers of the mix adopt the Flora Locale Code of Practice for collectors, growers and suppliers of native flora.



Flora 3 seed mix at point of sowing



Vegetation growth at 3 months



Vegetation established at 6 months



# WATERPROOFING OPTIONS

The Bauder portfolio of waterproofing systems ensures we impartially match the right solution for every project whether new build or refurbishment. These are our further options for roof covering systems to accompany a PV solution:

## Single Ply Systems

Our single ply roofing systems are ideal for lightweight, fast track and cost effective construction projects. The systems provide solutions that are durable, resistant to the natural elements and are able to support extensive green roofs.

- Projects: New build or refurbishment.
- Construction: Warm, cold and inverted roofs.
- PV System: Green roofs and BauderSOLAR flat roof.
- Certification: BBA, FM Approval.
- Guarantees: Full range to accompany the PV system.

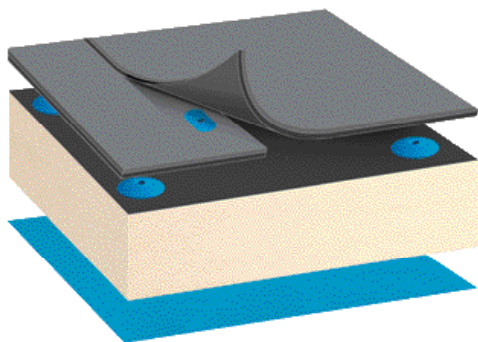

## Bitumen Membrane Systems

Our long-established and fully integrated roof systems incorporate SBS modified elastomeric bitumen membranes and highly efficient PIR insulation to give a robust waterproofing solution with long-term durability and life-expectancy. These systems are ideal for all types of green roof scenarios and solar PV.

- Projects: New build or refurbishment.
- Construction: Warm, cold and inverted roofs.
- Upgrades: Green roofs and BauderSOLAR flat roof or BioSOLAR photovoltaics.
- Certification: BBA.
- Guarantees: Full range to accompany PV system installed.



## Hot Melt Structural Waterproofing

The Bauder Hot Melt Structural Waterproofing System can be installed on decks with zero degree falls.

- Projects: New build.
- Construction: Cold and inverted roofs.
- Upgrades: Green Roofs and BioSOLAR photovoltaics.
- Guarantees: Full range to accompany BioSOLAR PV system.

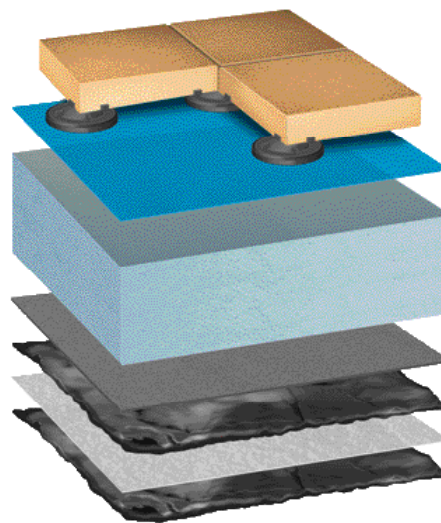



Our turnkey service supports you, is without charge, and follows these six simple steps



#### **1: Brief and Consultation**

You give us your remit either at your office or on site. We will discuss the roofing project, your budget and how the programme of works can be formulated to maximise benefits from your PV.

#### **2: Design and Specification Service**

You will receive the Bauder specification package for your project, which answers your brief and includes a technical layout of the PV units and system engineering.

#### **3: Grid Connections and Funding Options**

Our in depth understanding of energy efficiency funding can help you find the financial package that best suits your circumstances. We can help size the array for optimum return on investment based on electricity consumption data supplied.

#### **4: Contractor Selection**

Your Bauder technical manager will assist in the selection of appropriate contractors from a national network of MCS accredited contractors who are approved in the installation of Bauder's various roof and PV systems. Once the contractor has been appointed, a pre-contract meeting will make sure the project delivery is well coordinated. The works are closely monitored by Bauder site technicians with regular inspections to ensure quality and waterproof integrity of the final scheme.

#### **5. Sign Off and Guarantee**

A full final inspection is undertaken by the Bauder PV team on completion of the works with the energy performance of the array assessed. Comprehensive guarantees for the roof and PV system are provided.

#### **6. Monitoring and Maintenance**

Proactive monitoring systems enable us to ensure the maximum possible energy generation and financial return over the system's lifespan, and to identify faults or maintenance requirements remotely. After the project has been successfully completed Bauder can continue to support you with aftercare advice and post occupancy evaluation.

# GENERAL DETAILING

## BauderSOLAR

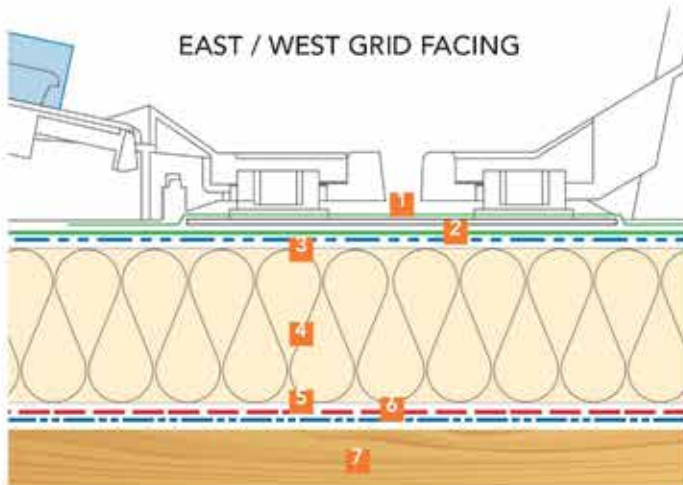
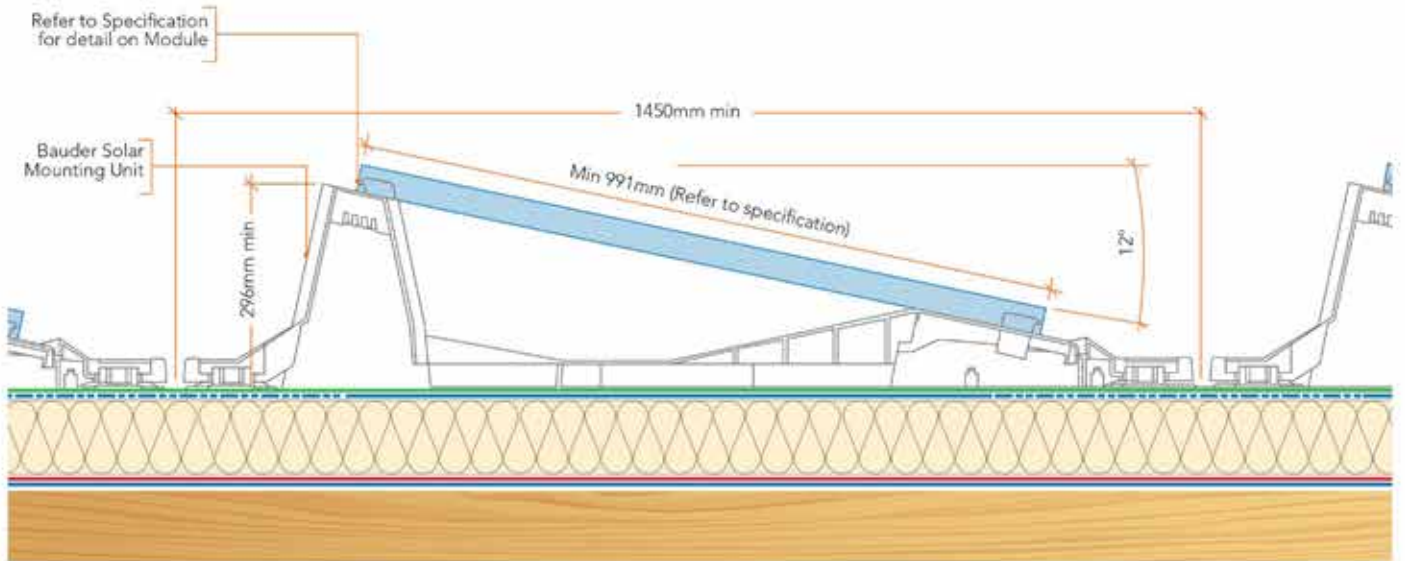

### Key

1. BauderSOLAR Membrane Sleeve
2. Bauder Cap Sheet
3. Bauder Underlayer
4. Bauder Insulation
5. Bauder Air and Vapour Control Layer
6. Bauder Random Nailed Layer used on timber boarded decks only
7. Unknown Deck/Substrate

Solar Module Unit Connection

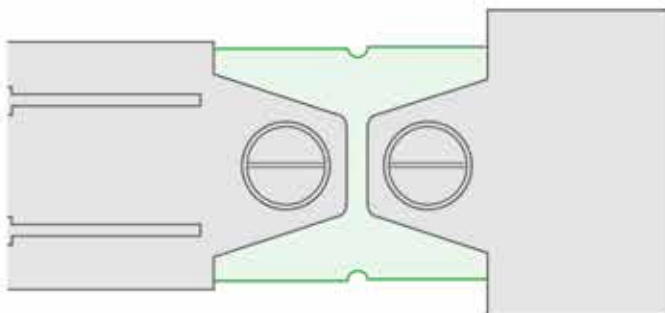

Top View: Mounting Unit Connection



## Bauder Biosolar Module Section - Cross Section

