

Architectural drawing showing a floor plan and a section view of a building. The drawing includes dimensions and structural details.

Pos. 001, Quantity: 1
Job: Guardian 182919
System: AluK GB 58BW / 58BD Commercial - 58BW OH+58BW Casement (AW620 vent only) Square Push In
Exterior View

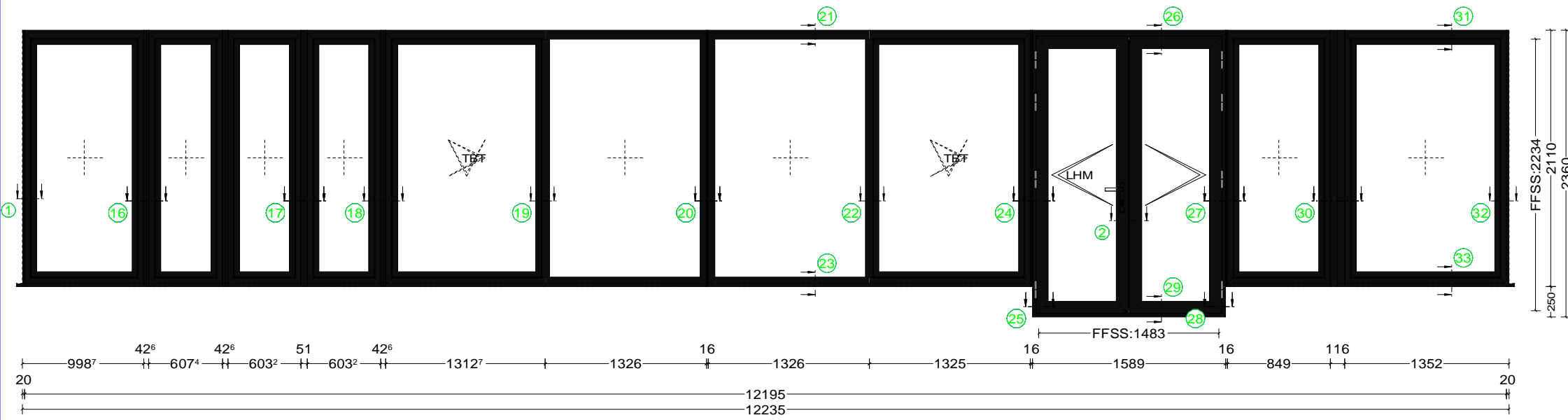

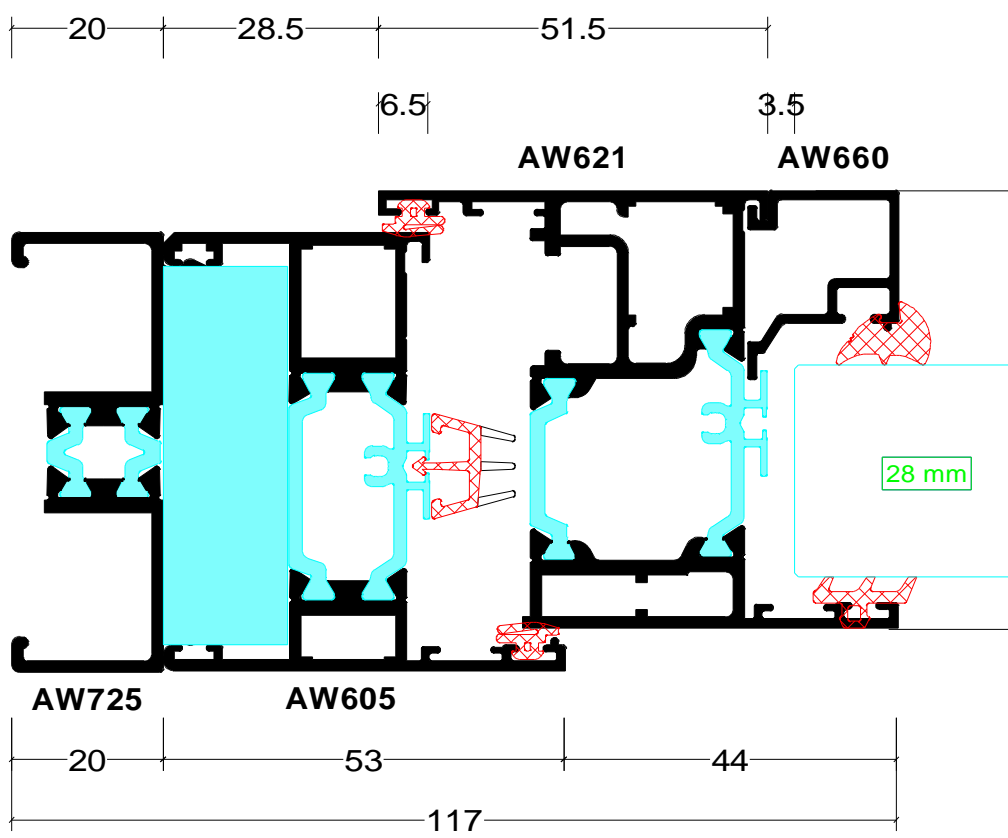

Section 1

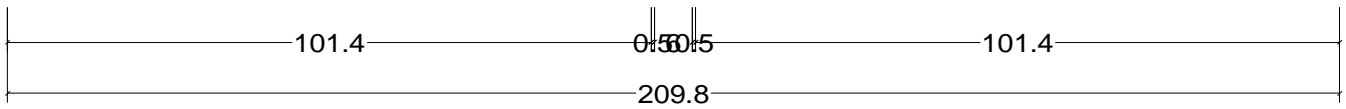
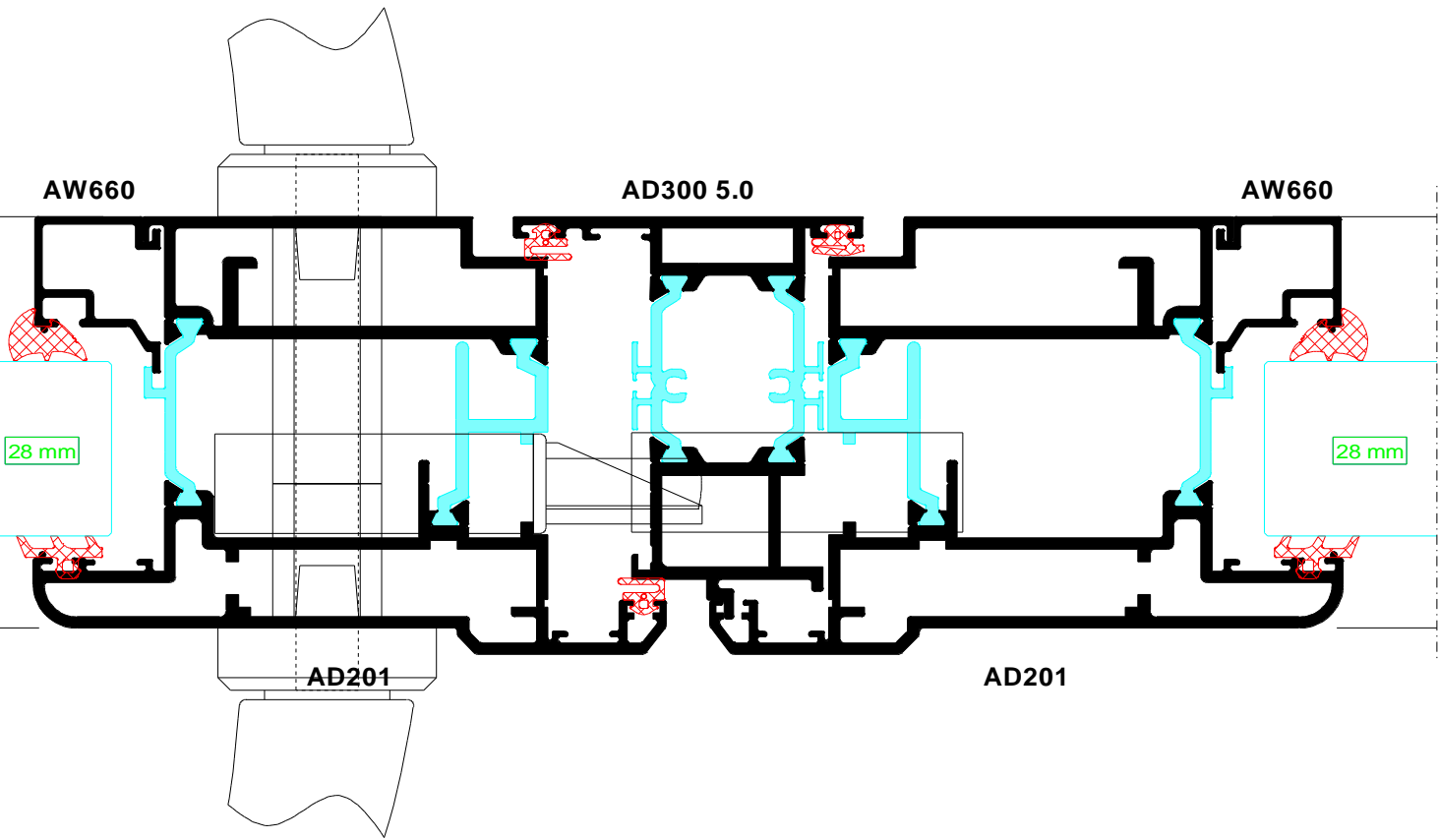
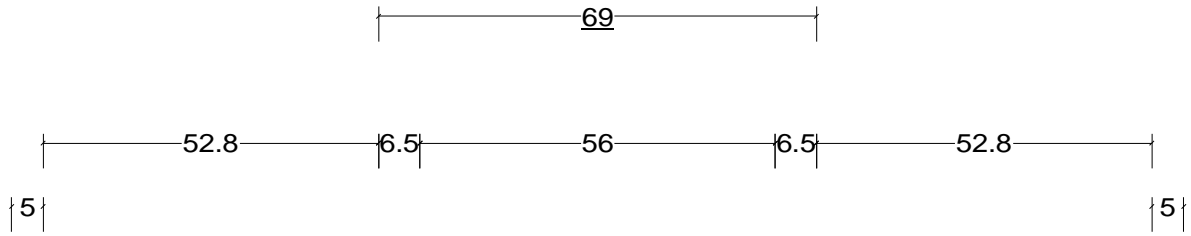

Section 3



Section 4



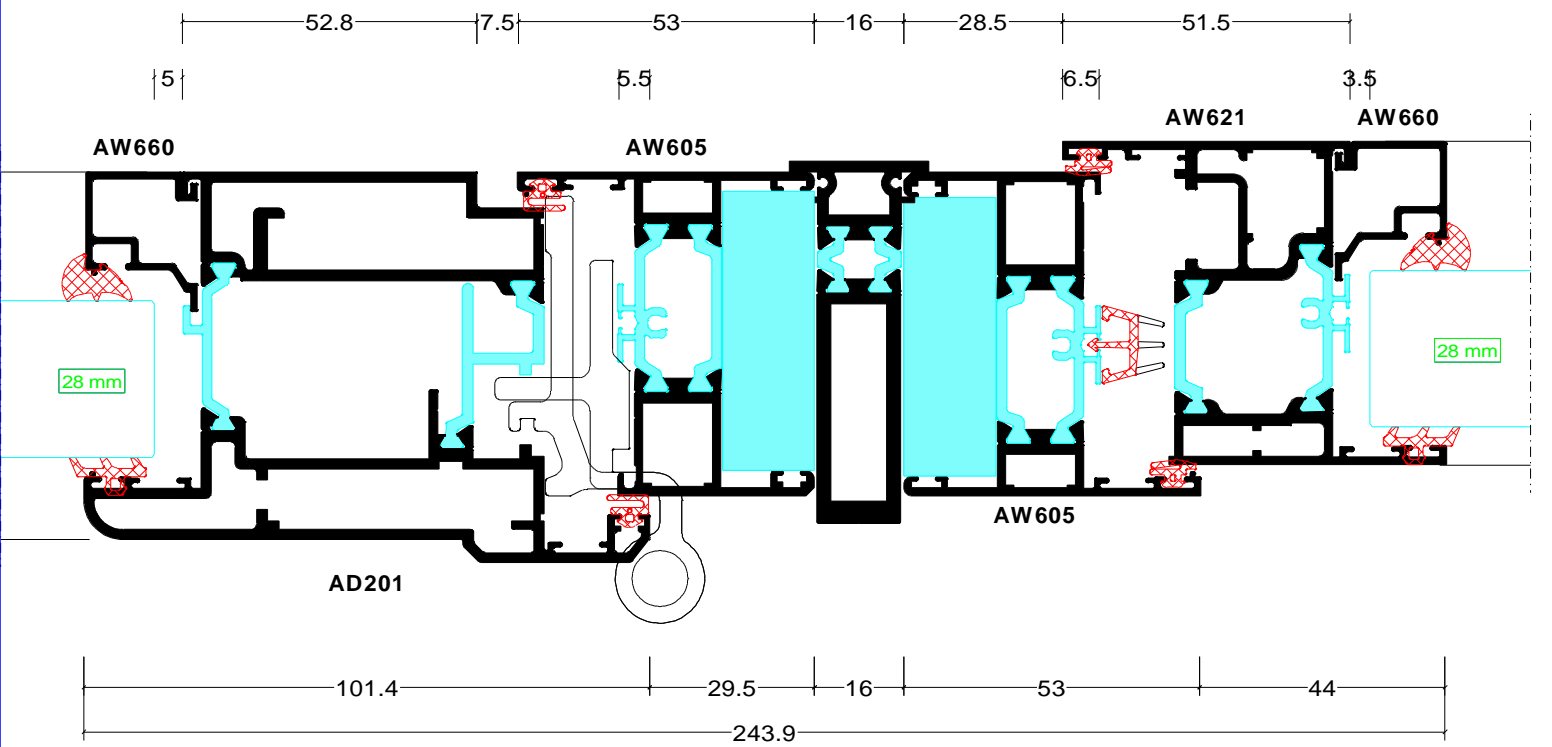

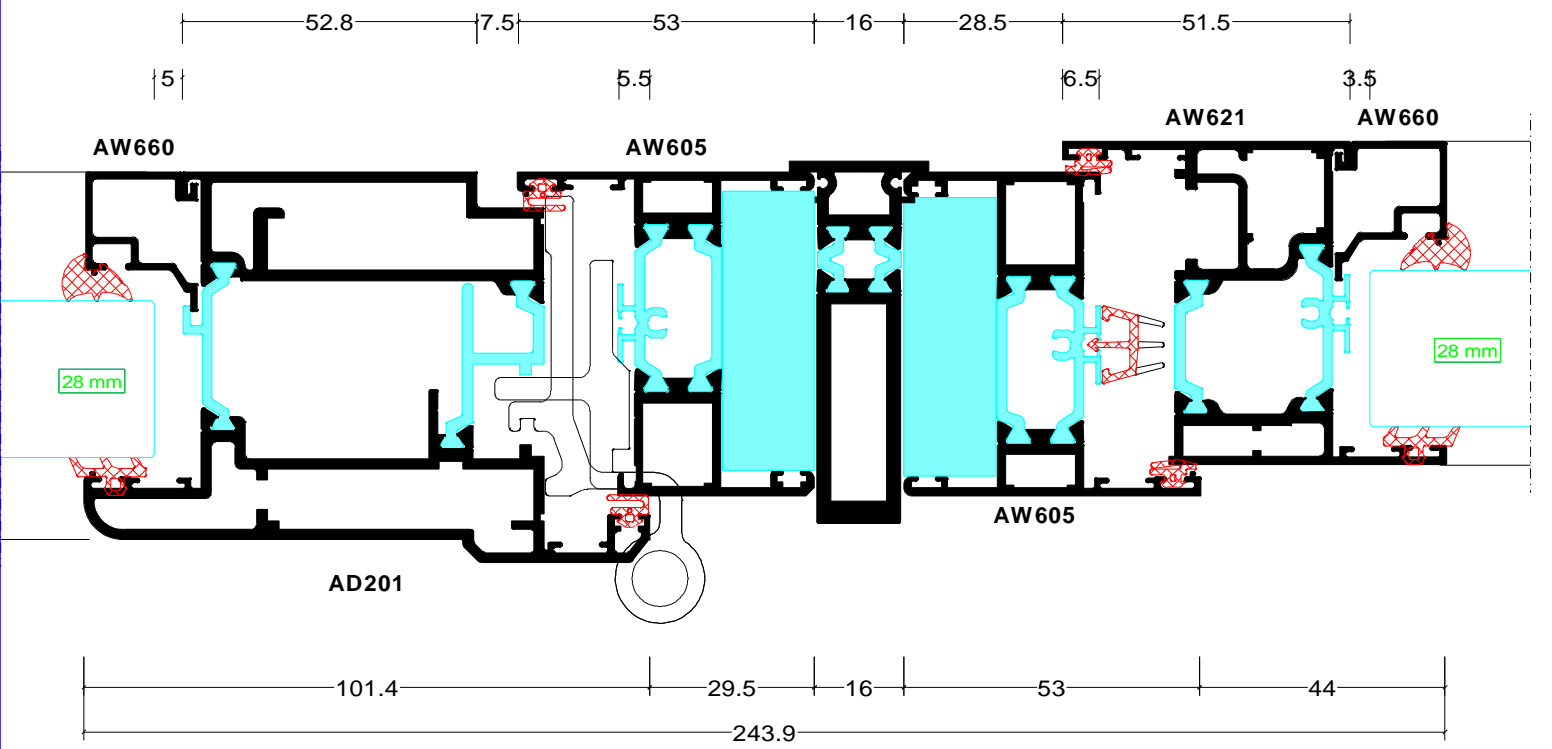

Section 7

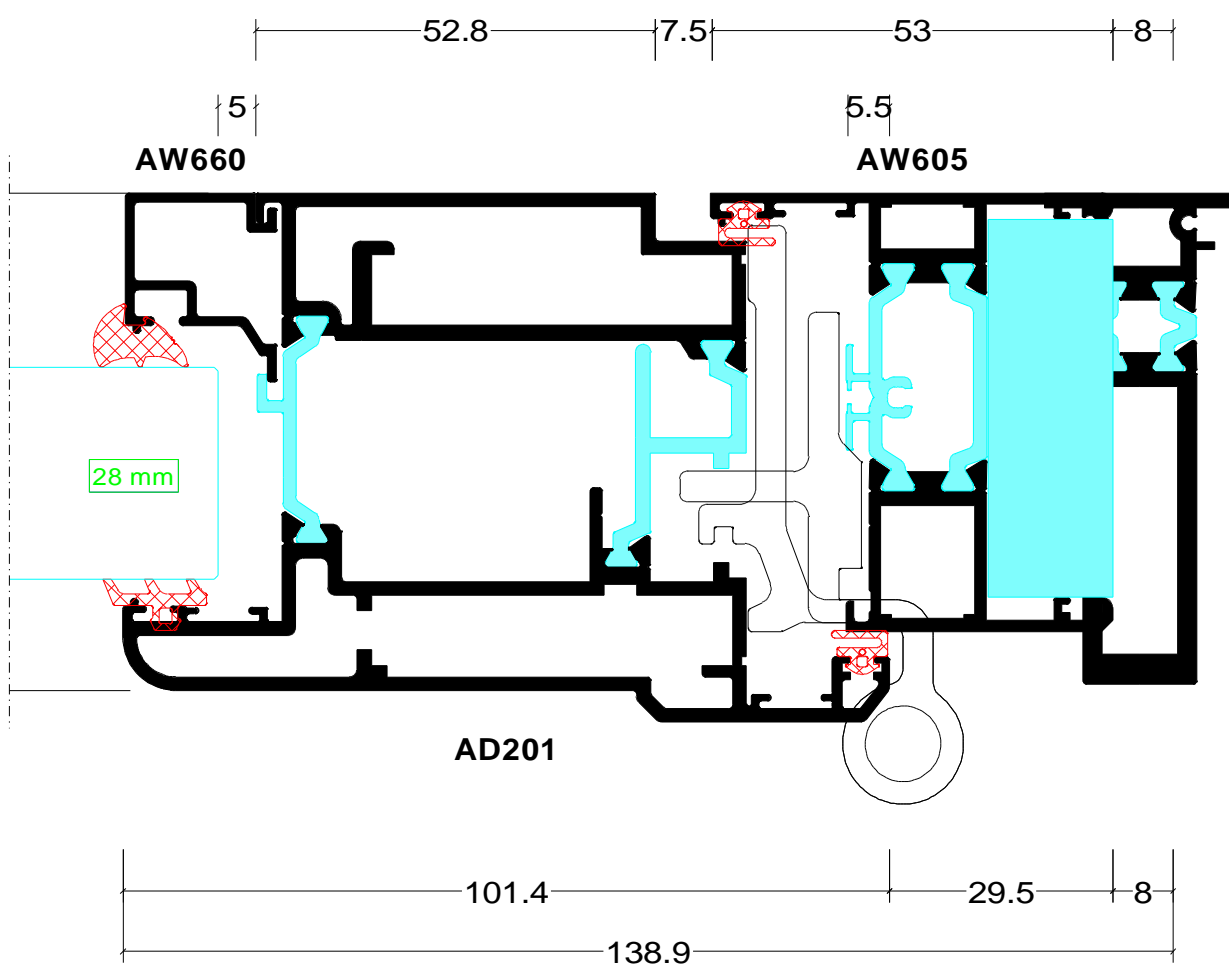

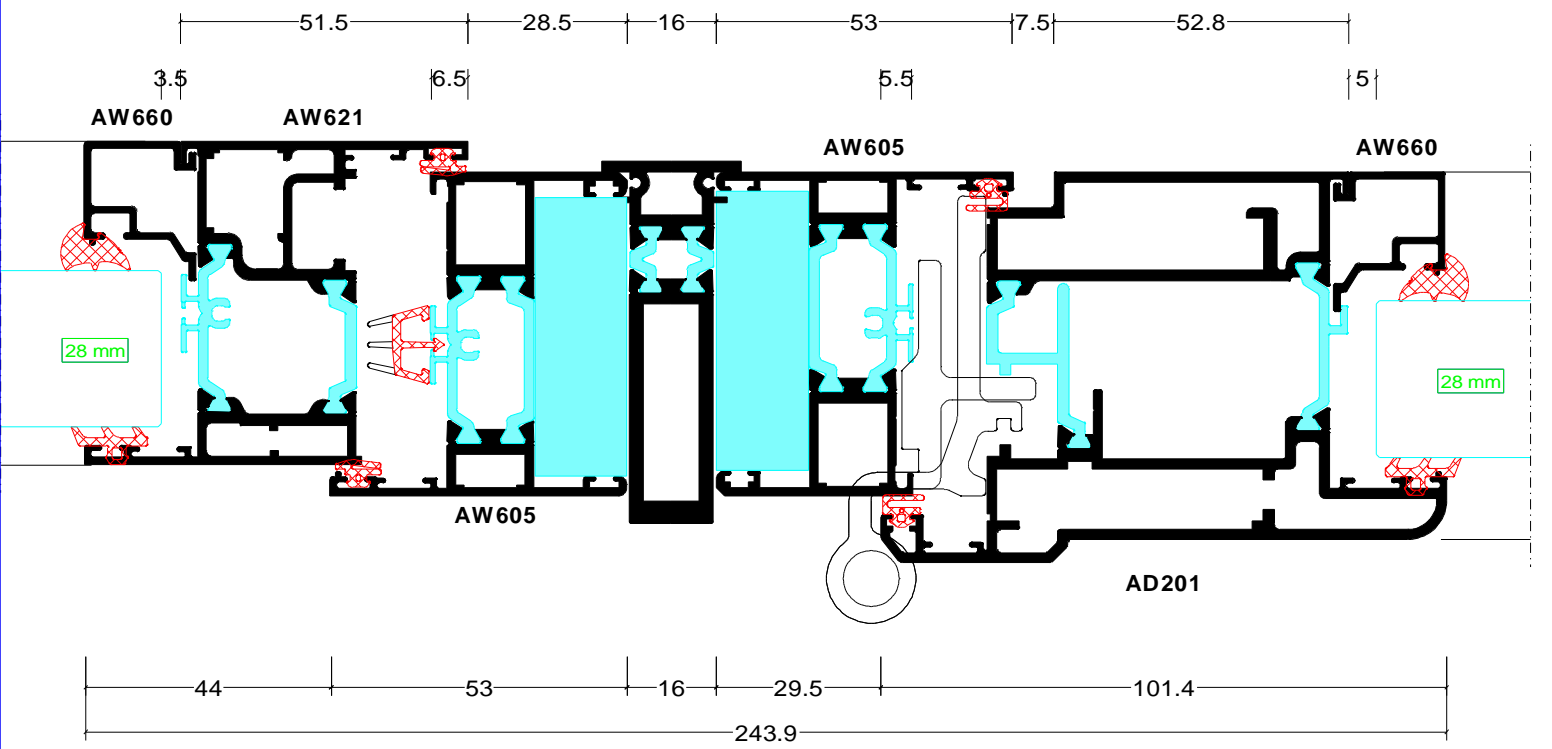

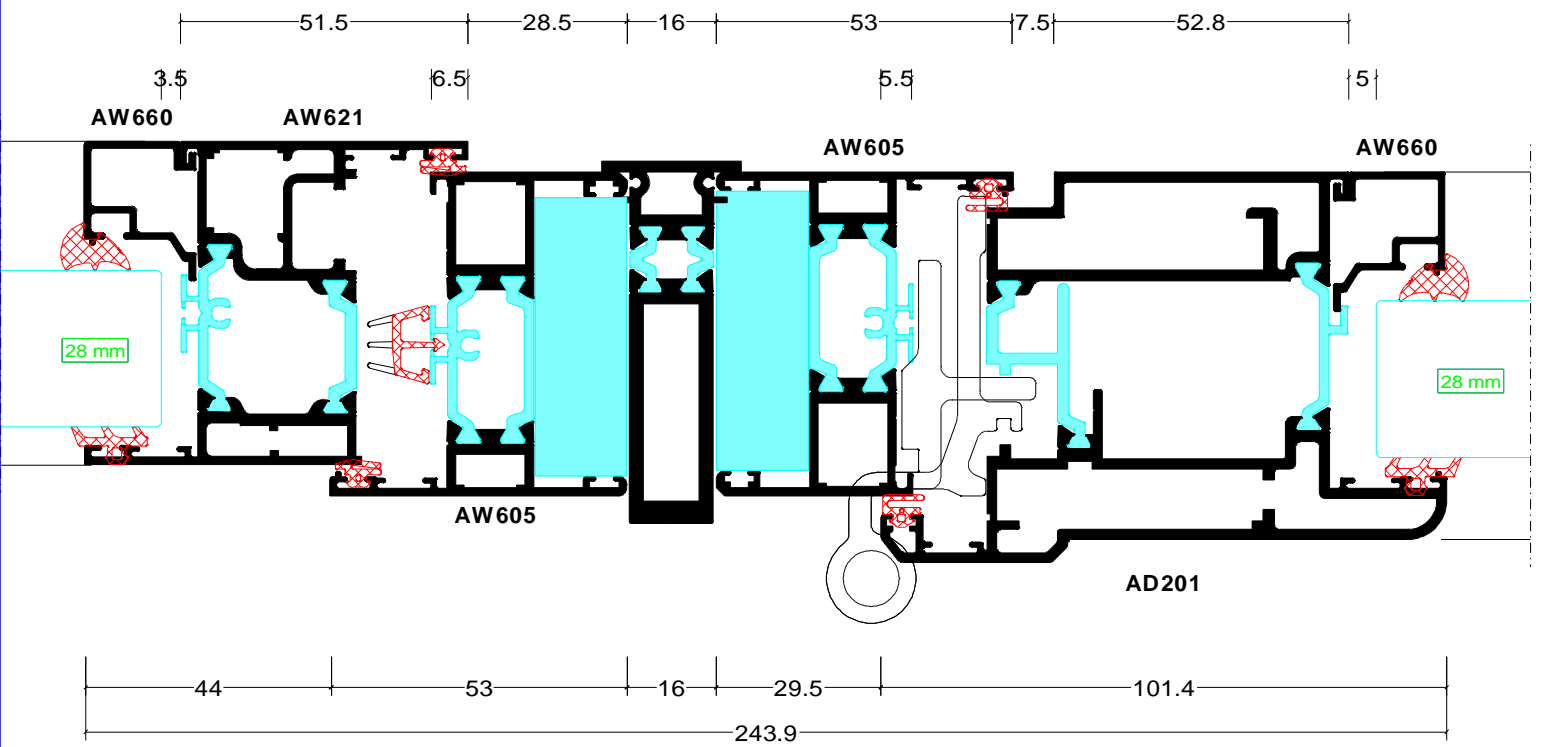

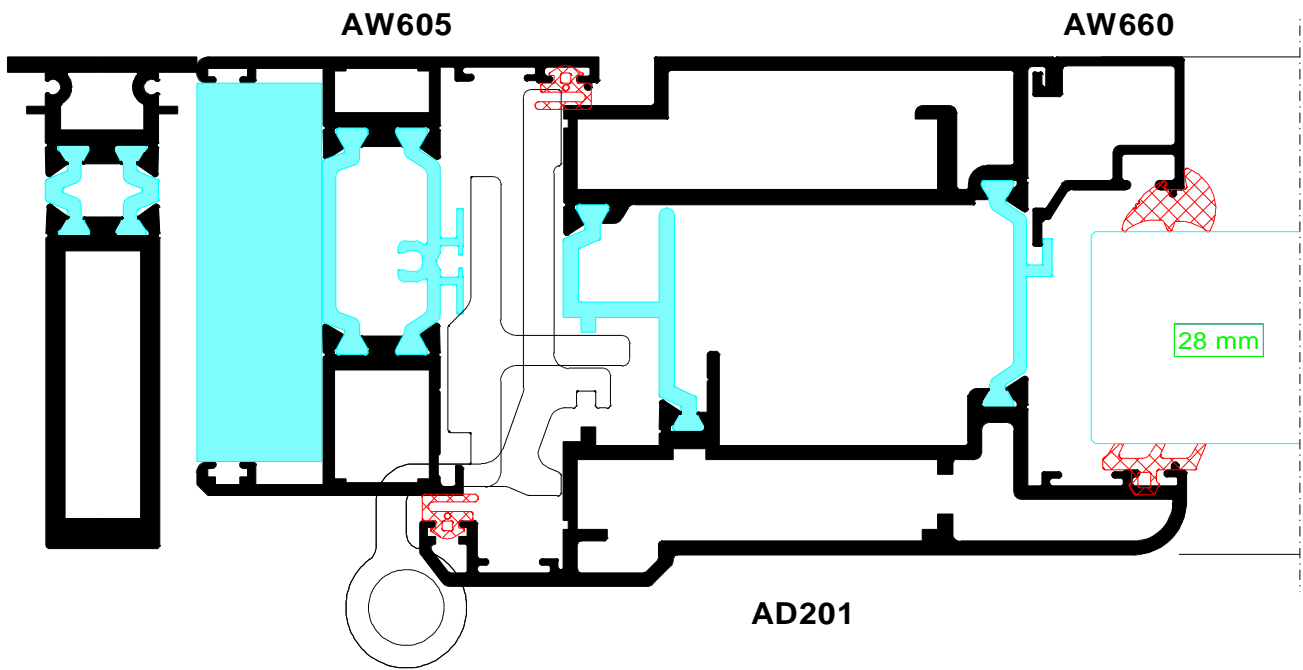

Section 10

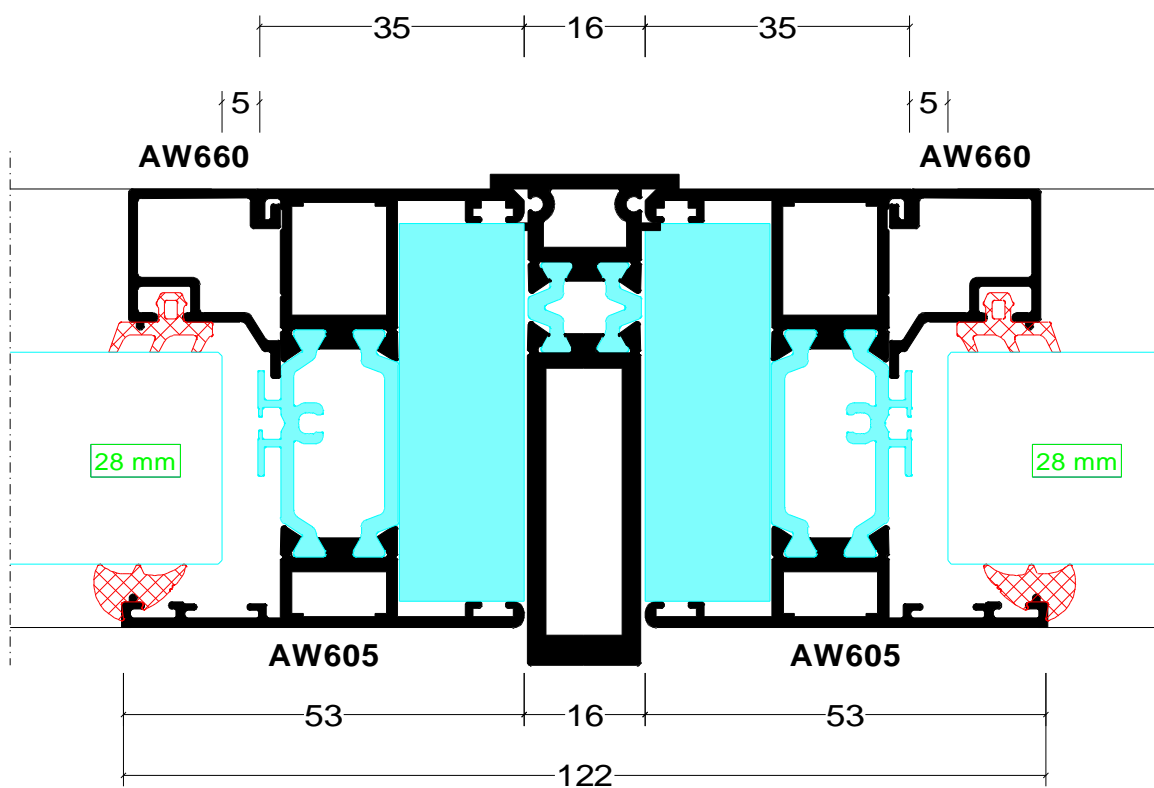

Section 11

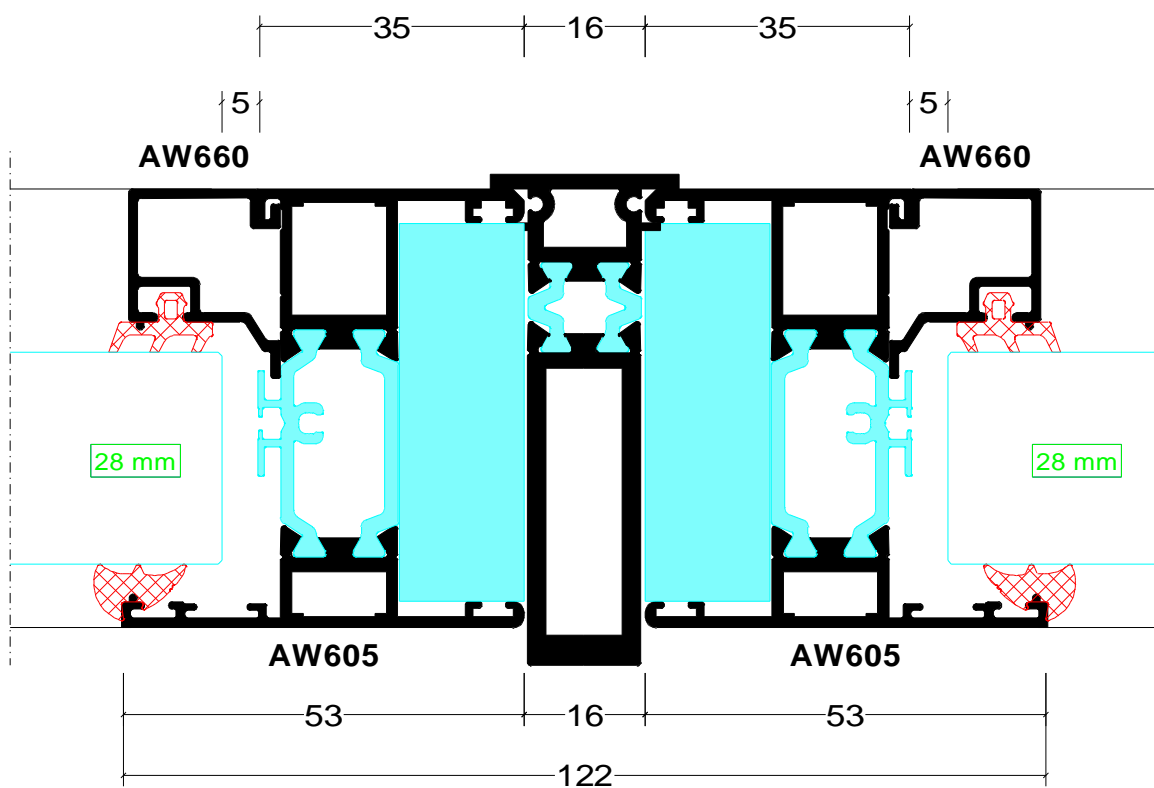

Section 12

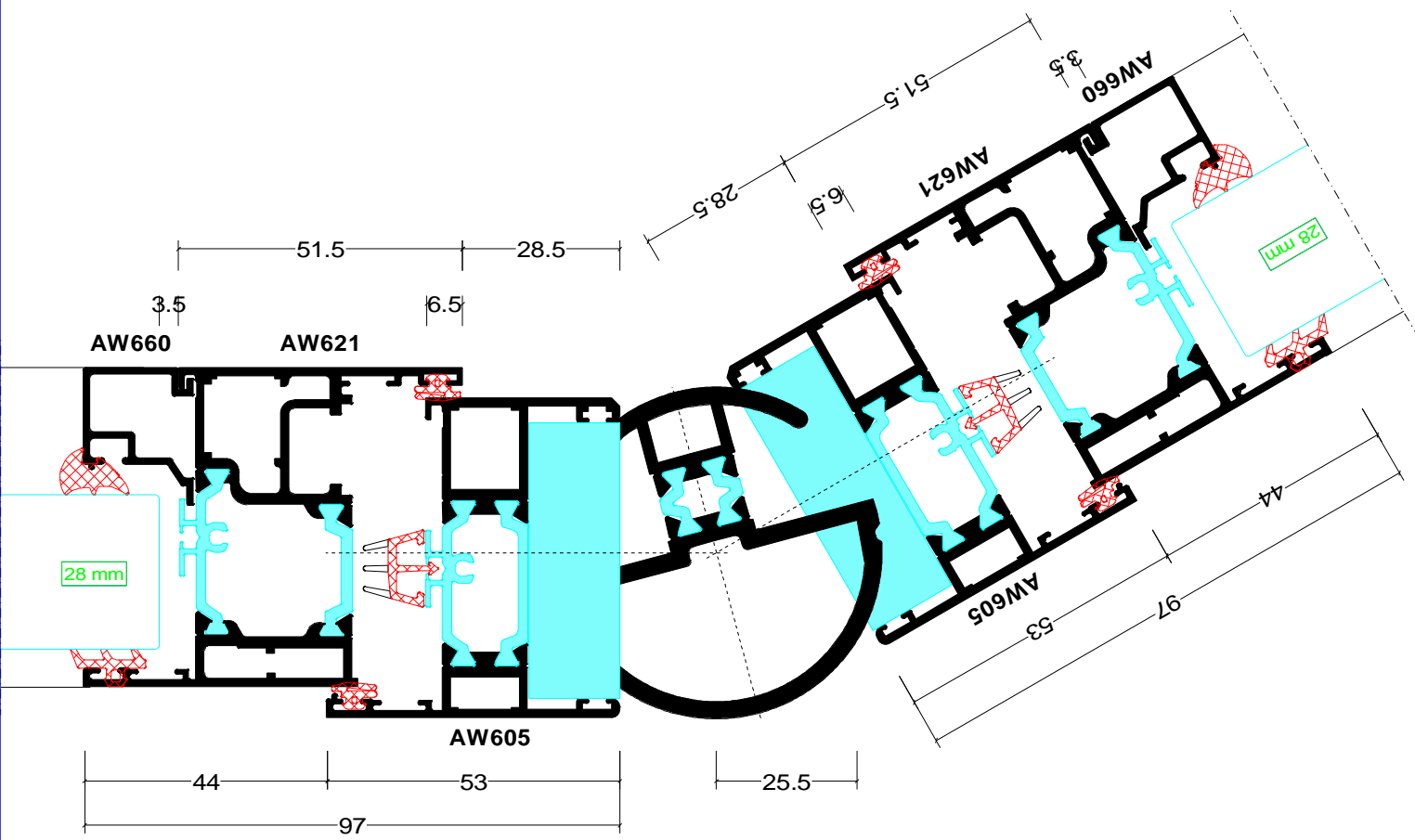

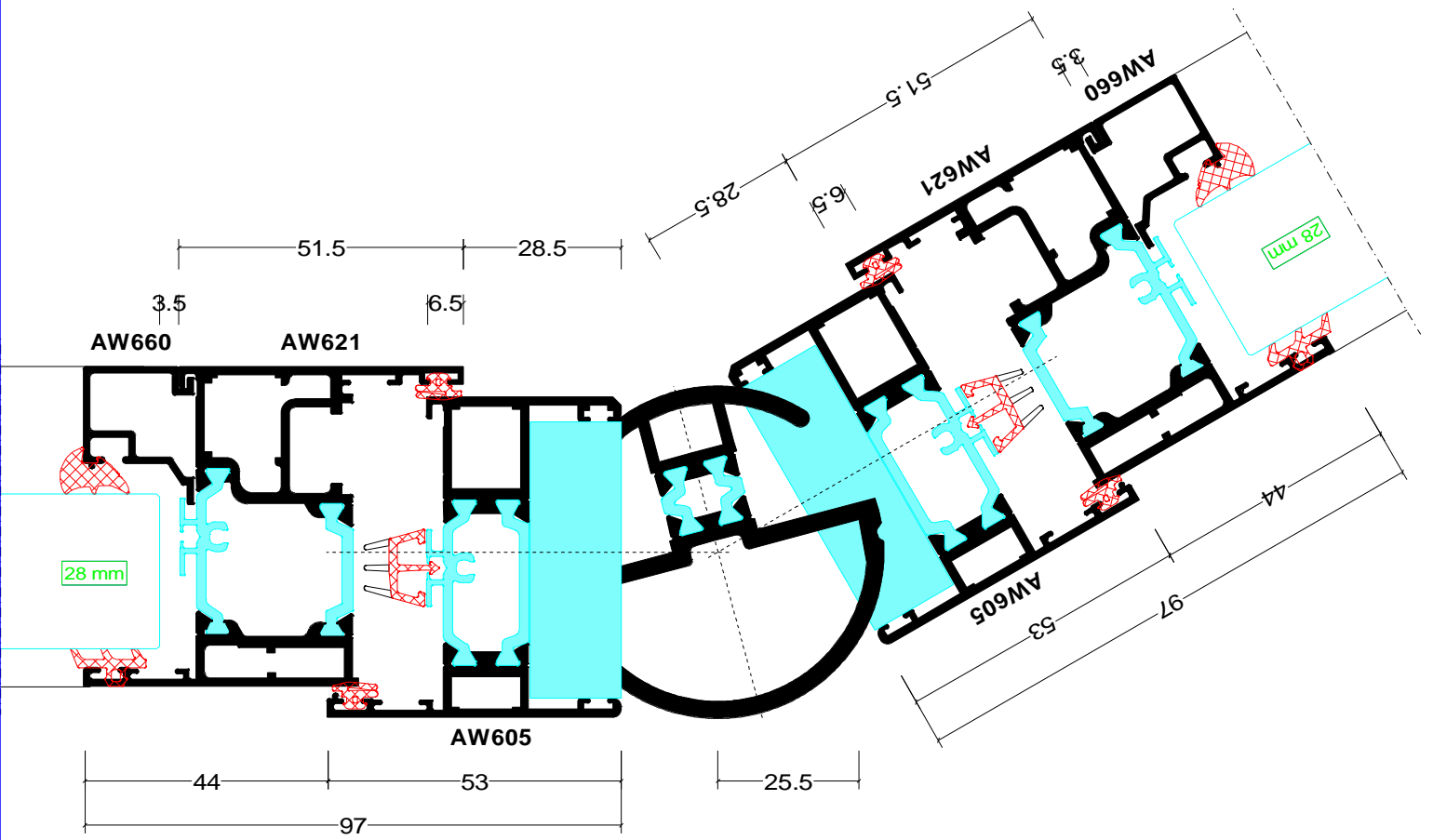

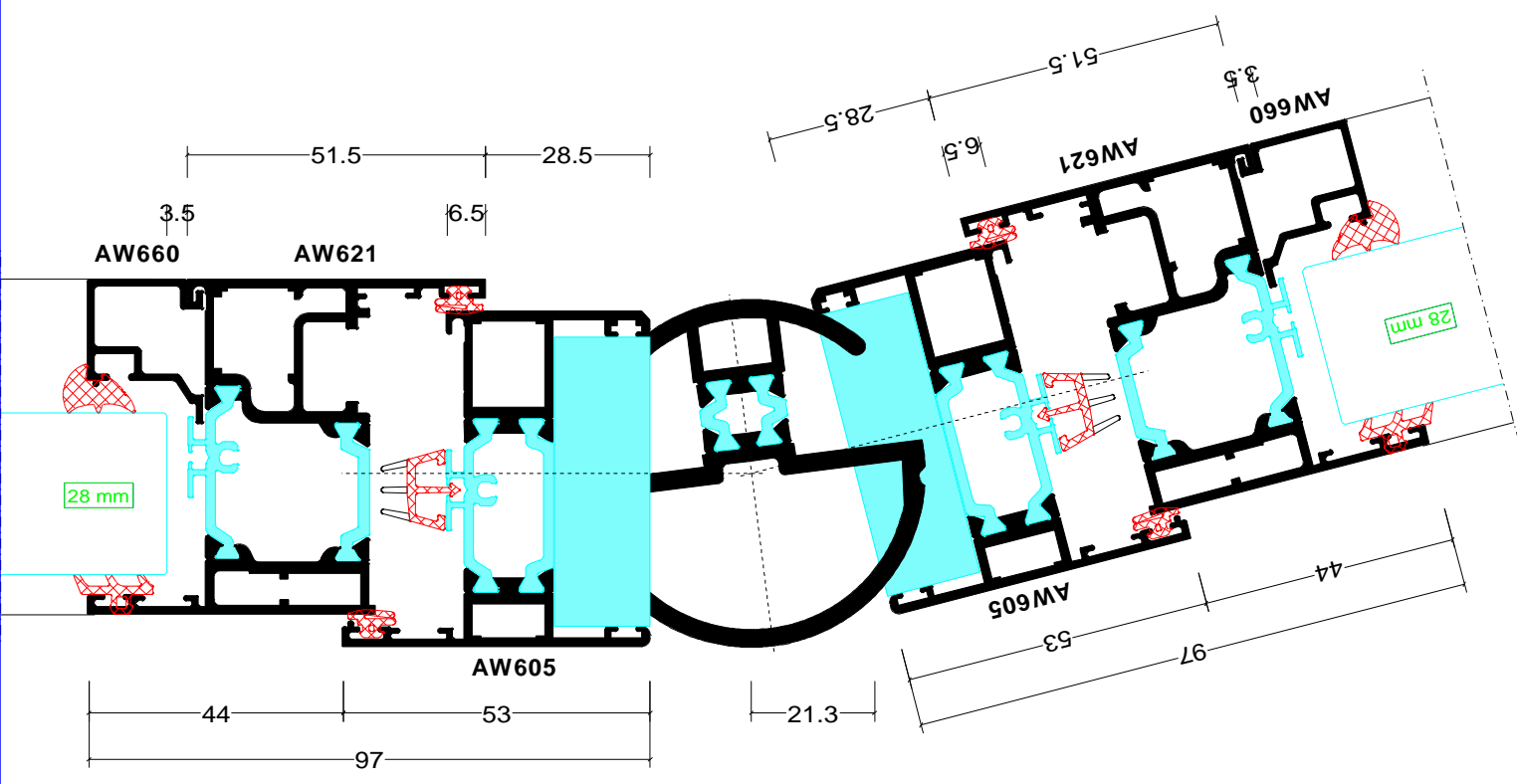

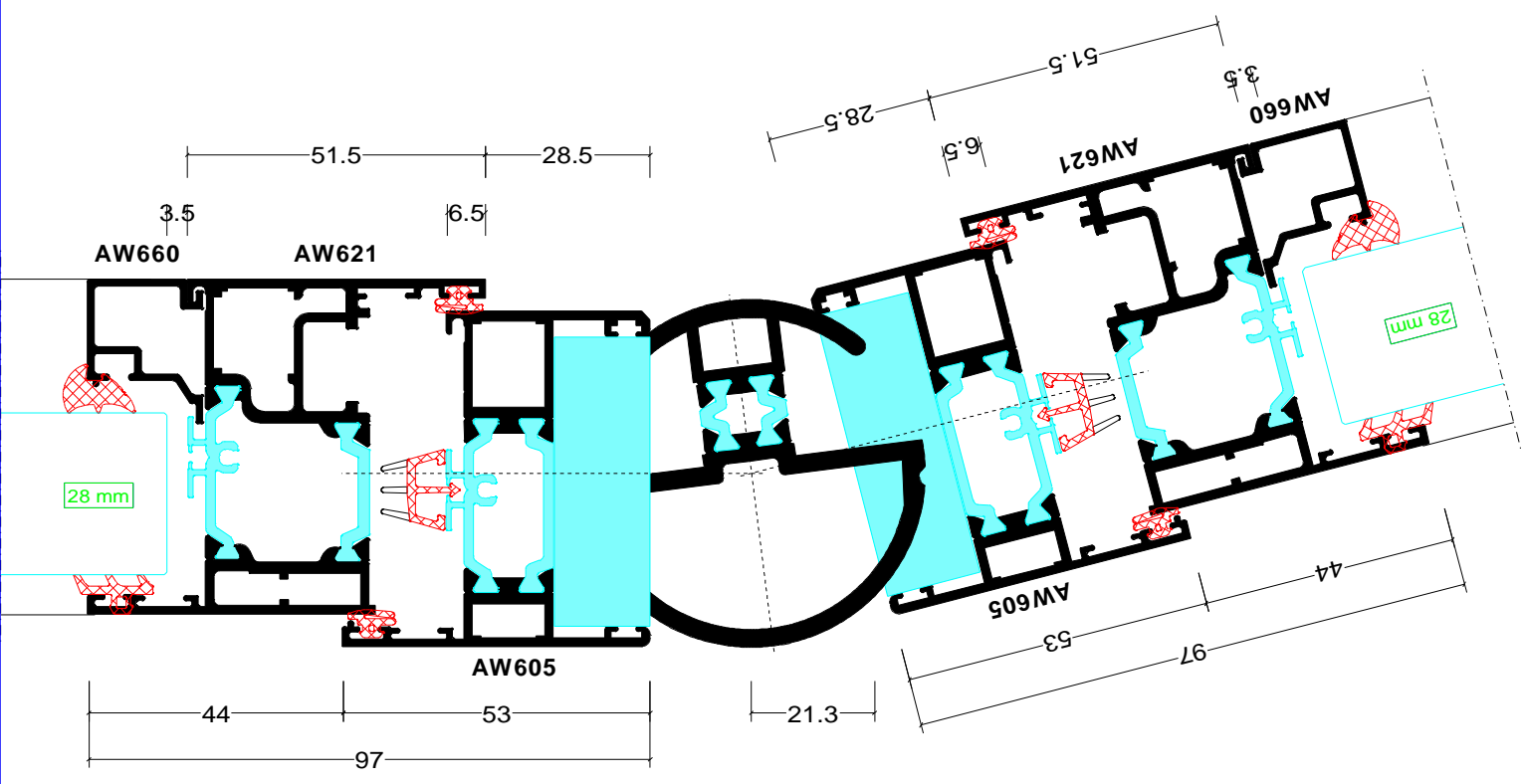

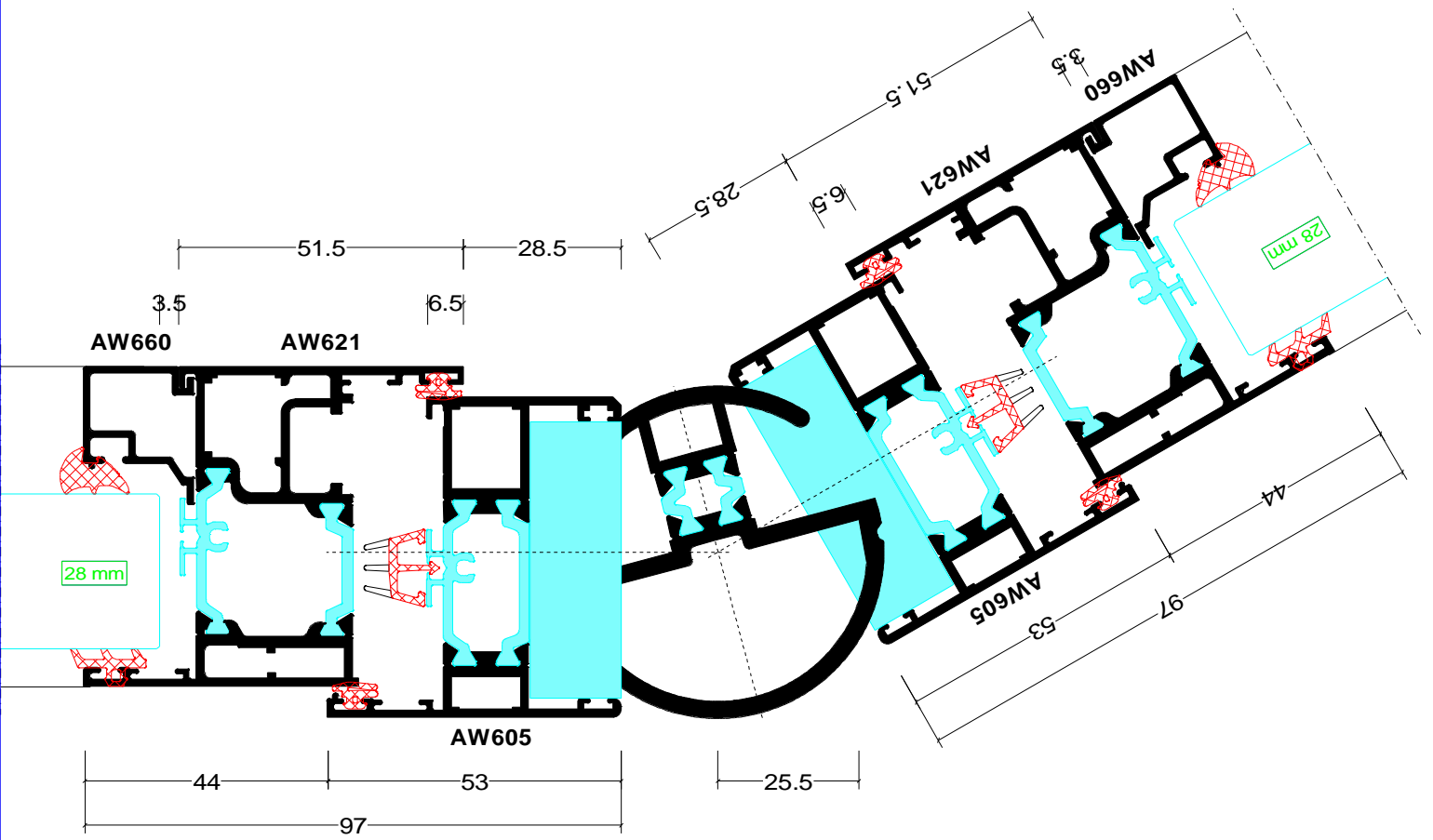

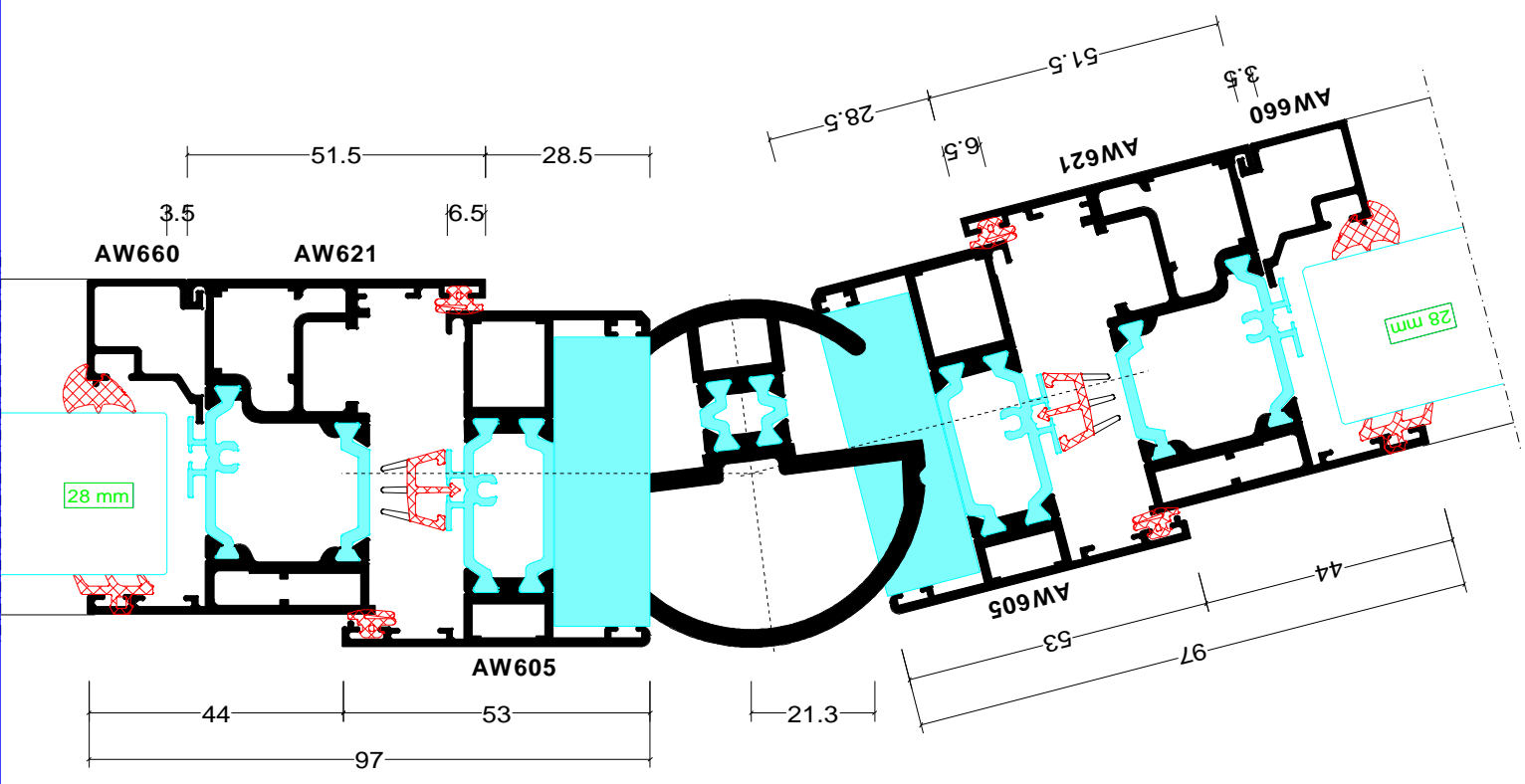

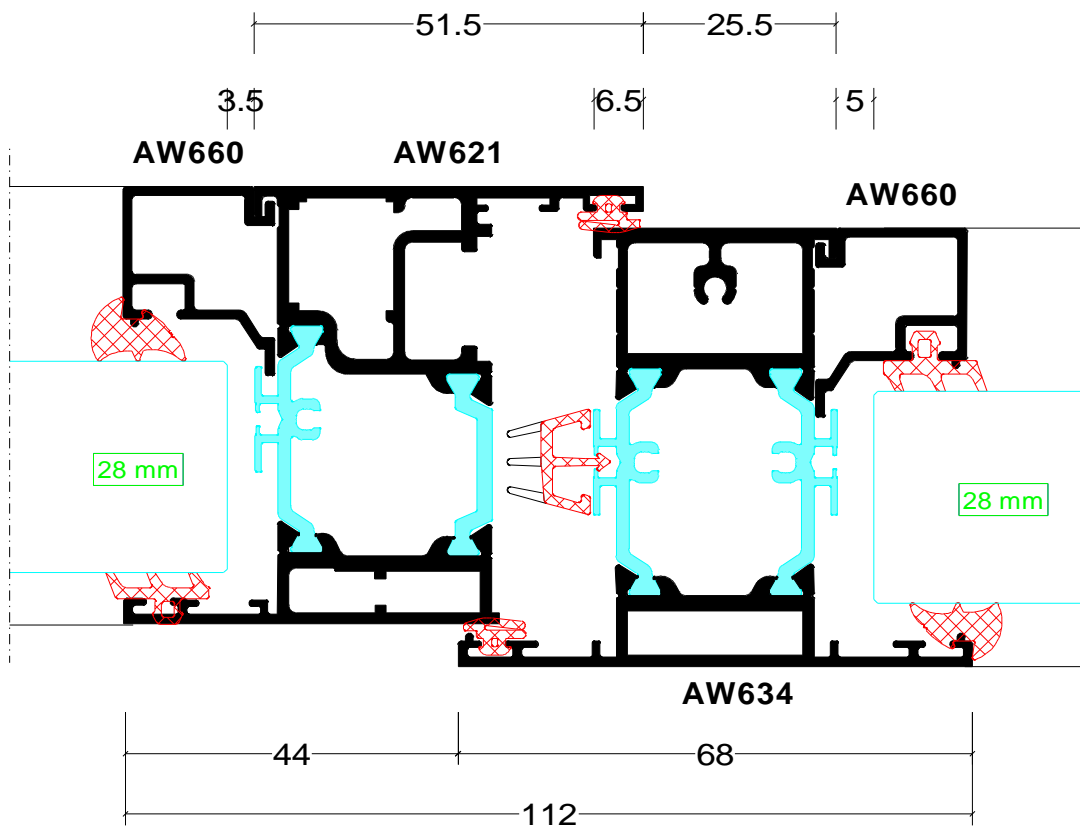

Section 19

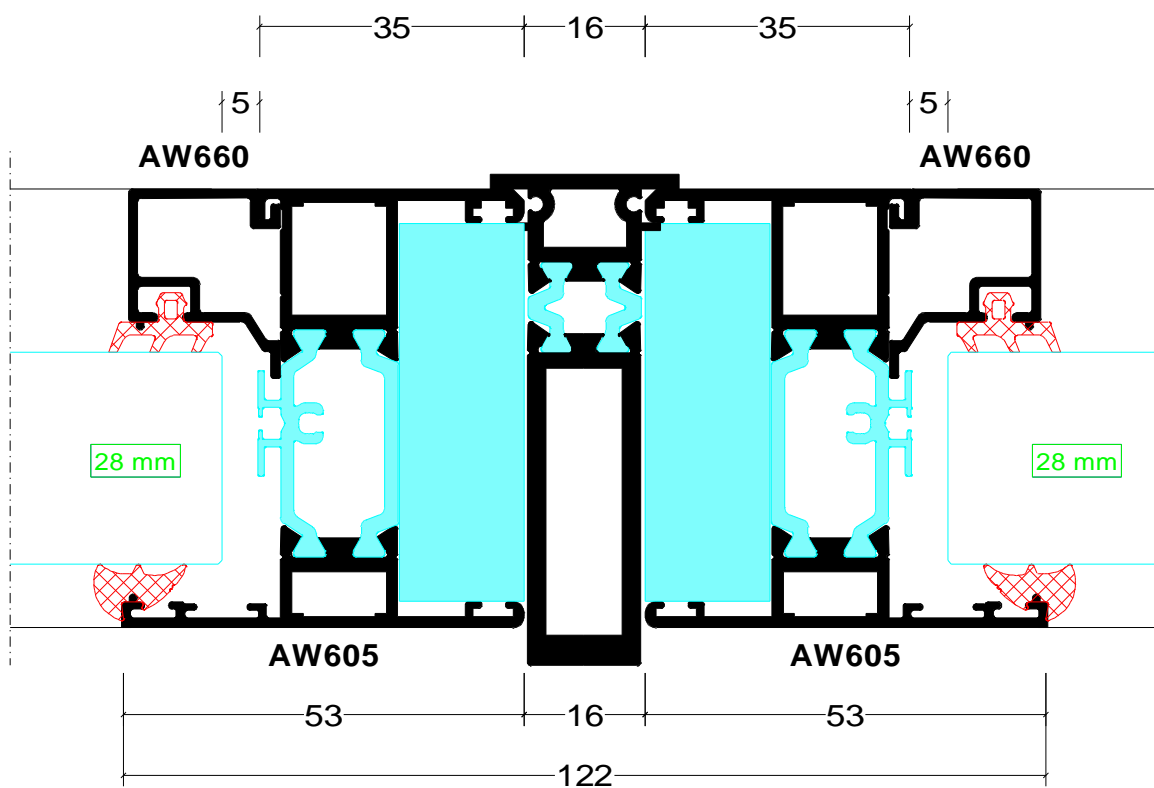

Section 20

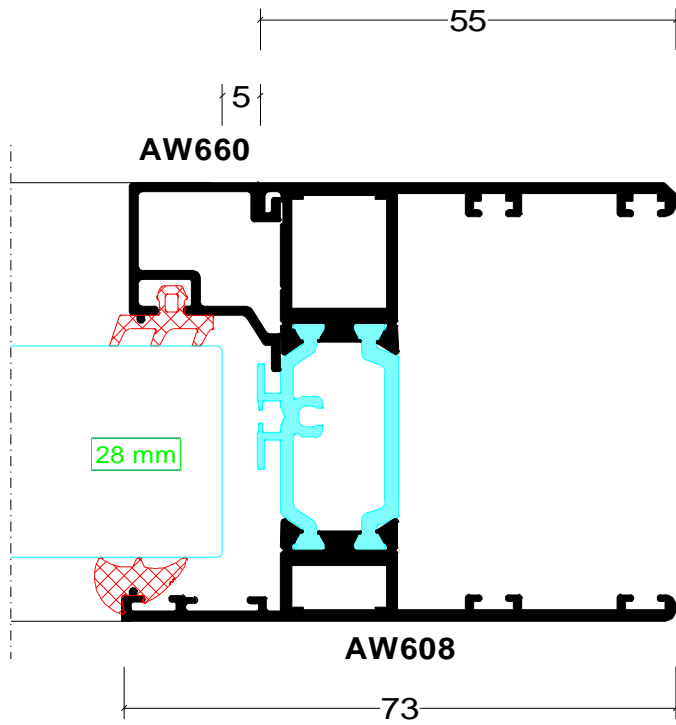

Section 21

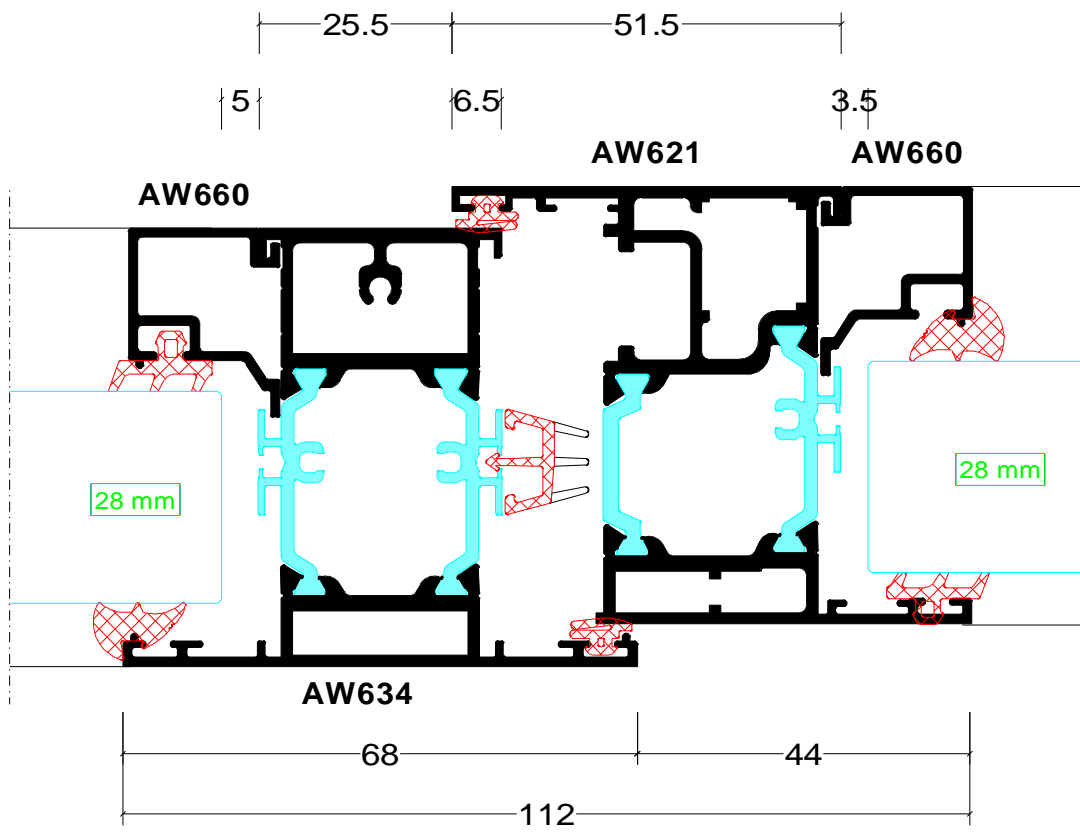

Section 22

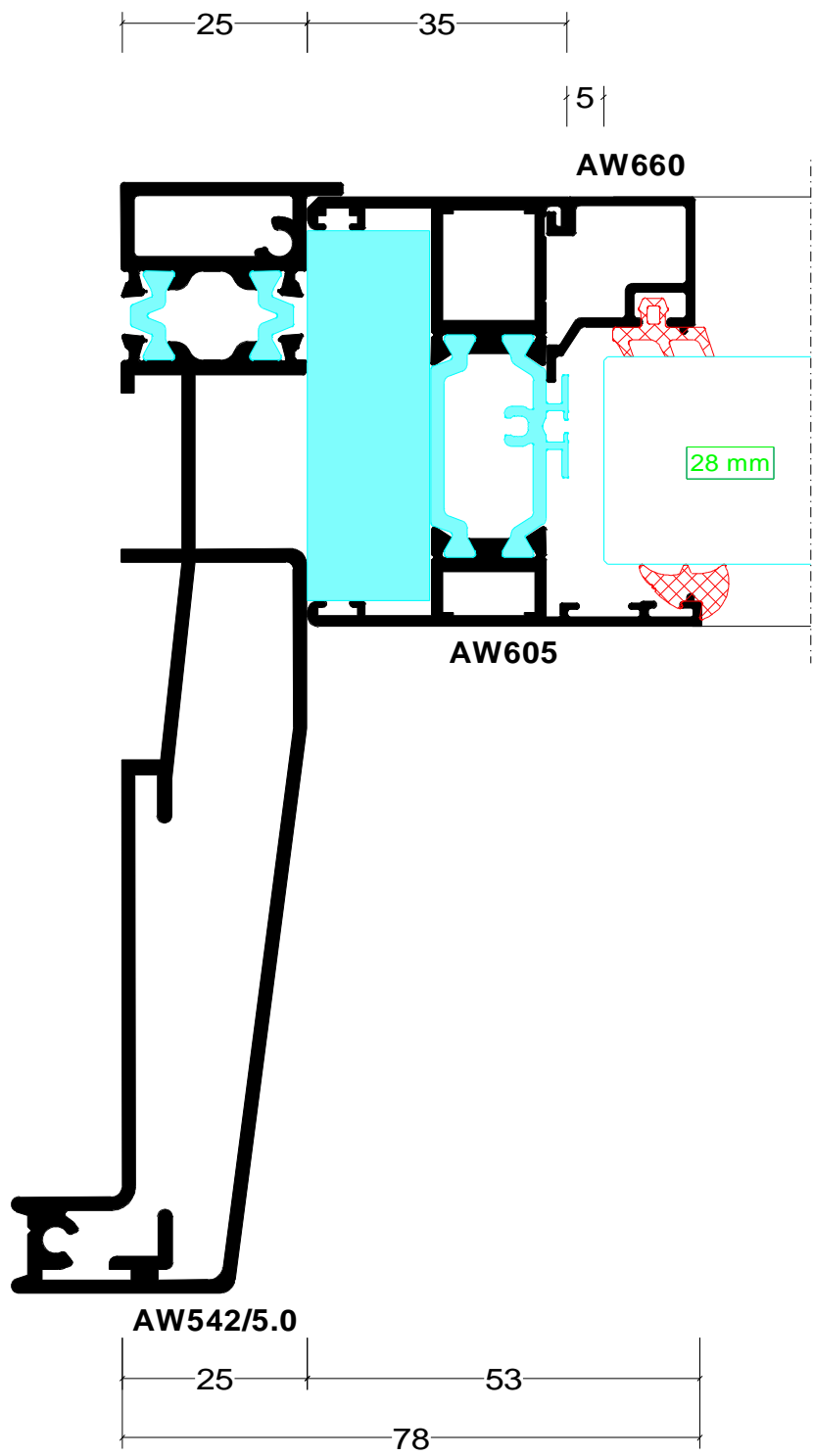

Section 23

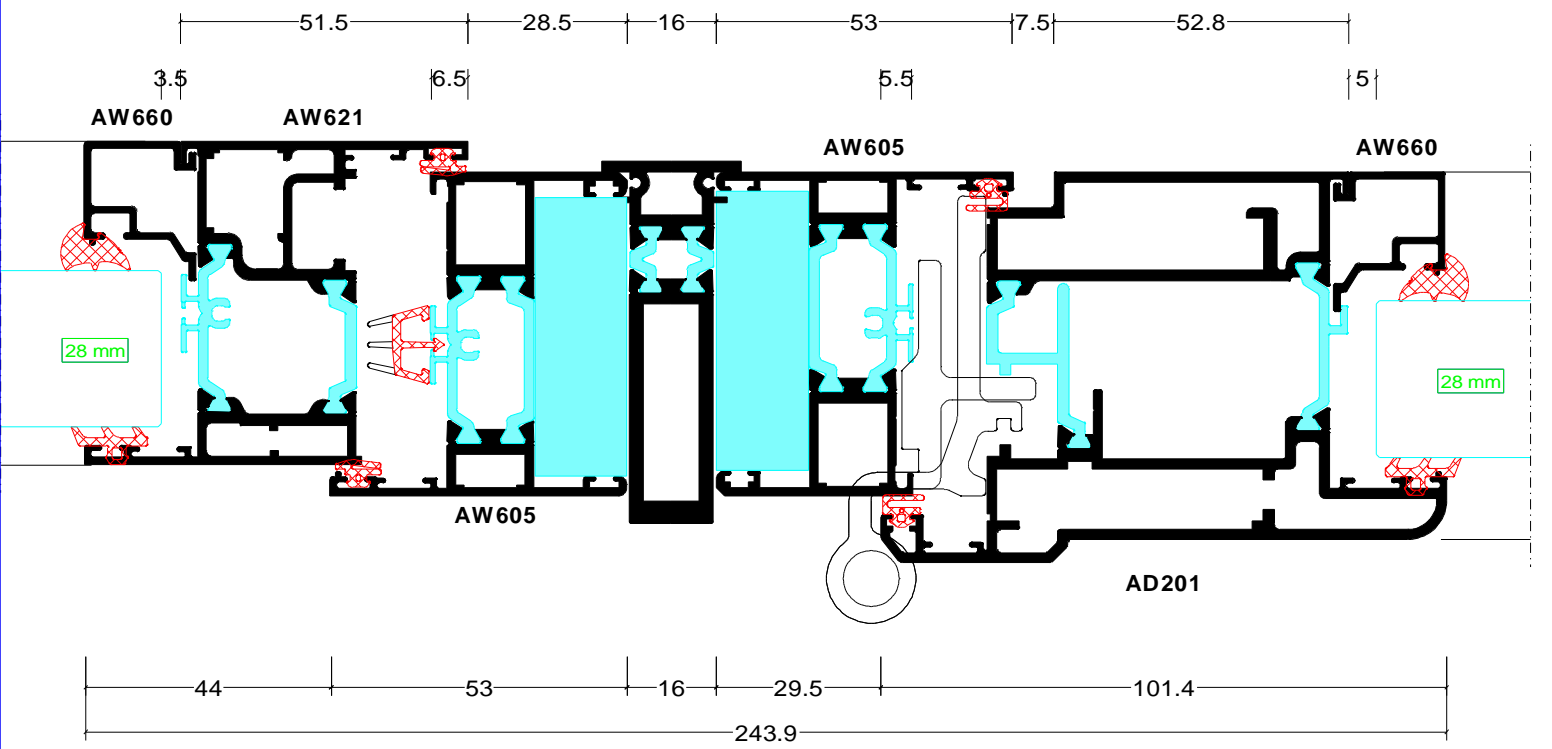

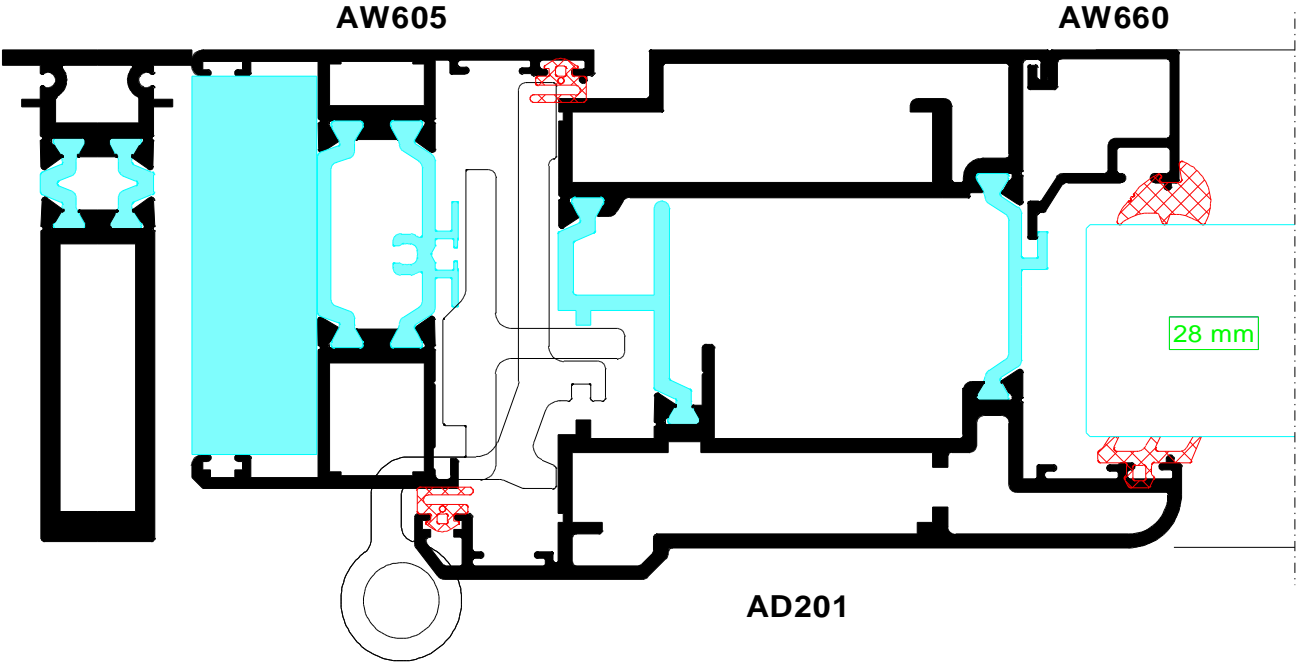

Section 25

Section 26

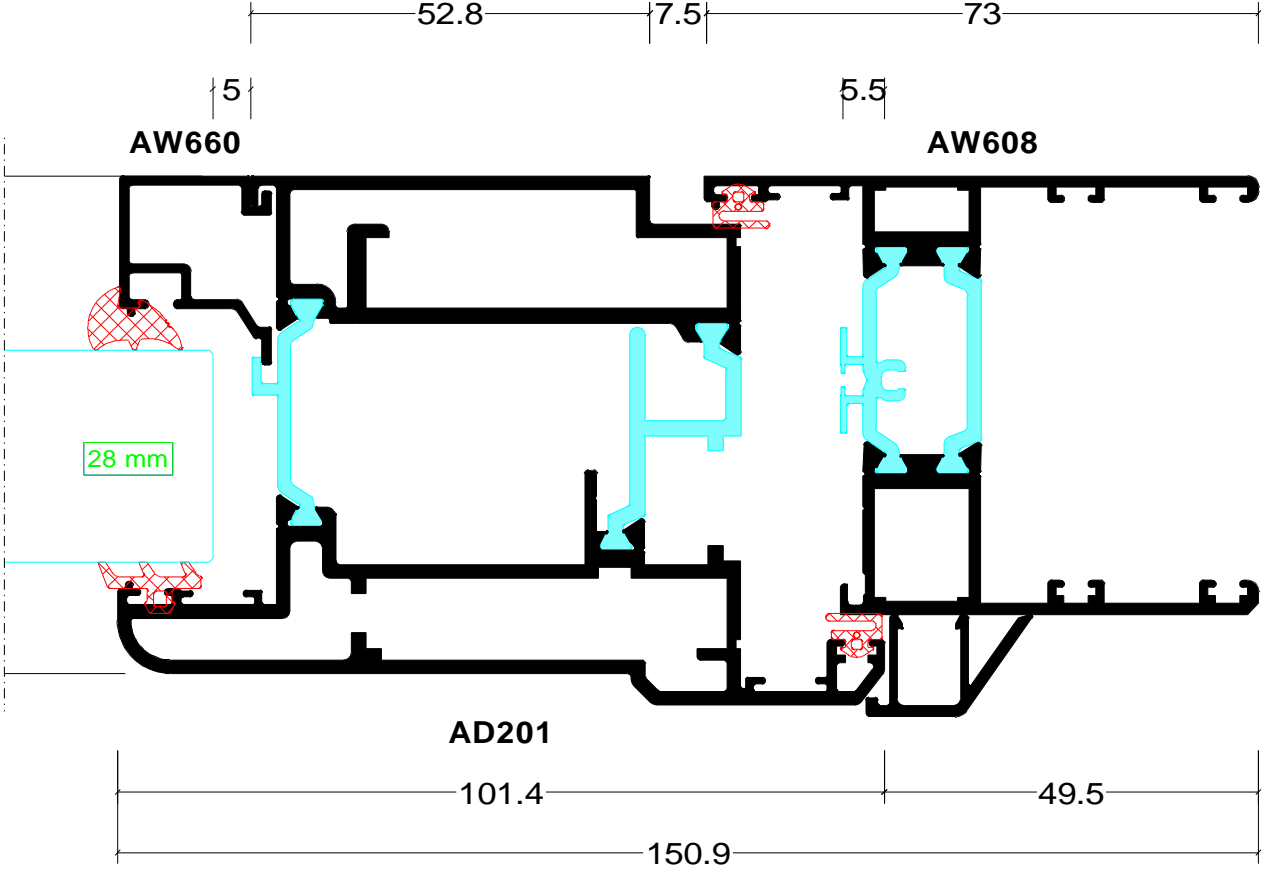

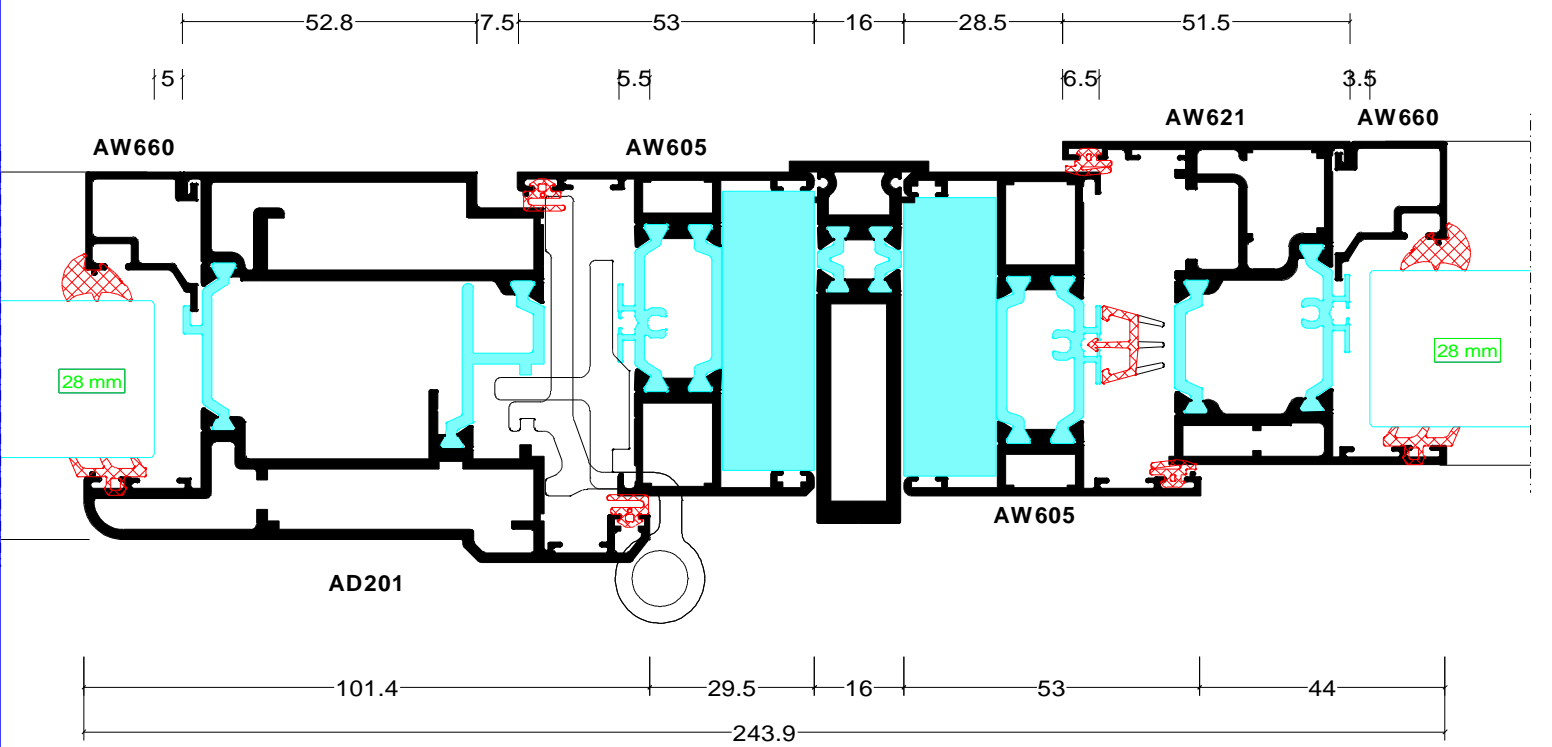

Section 28

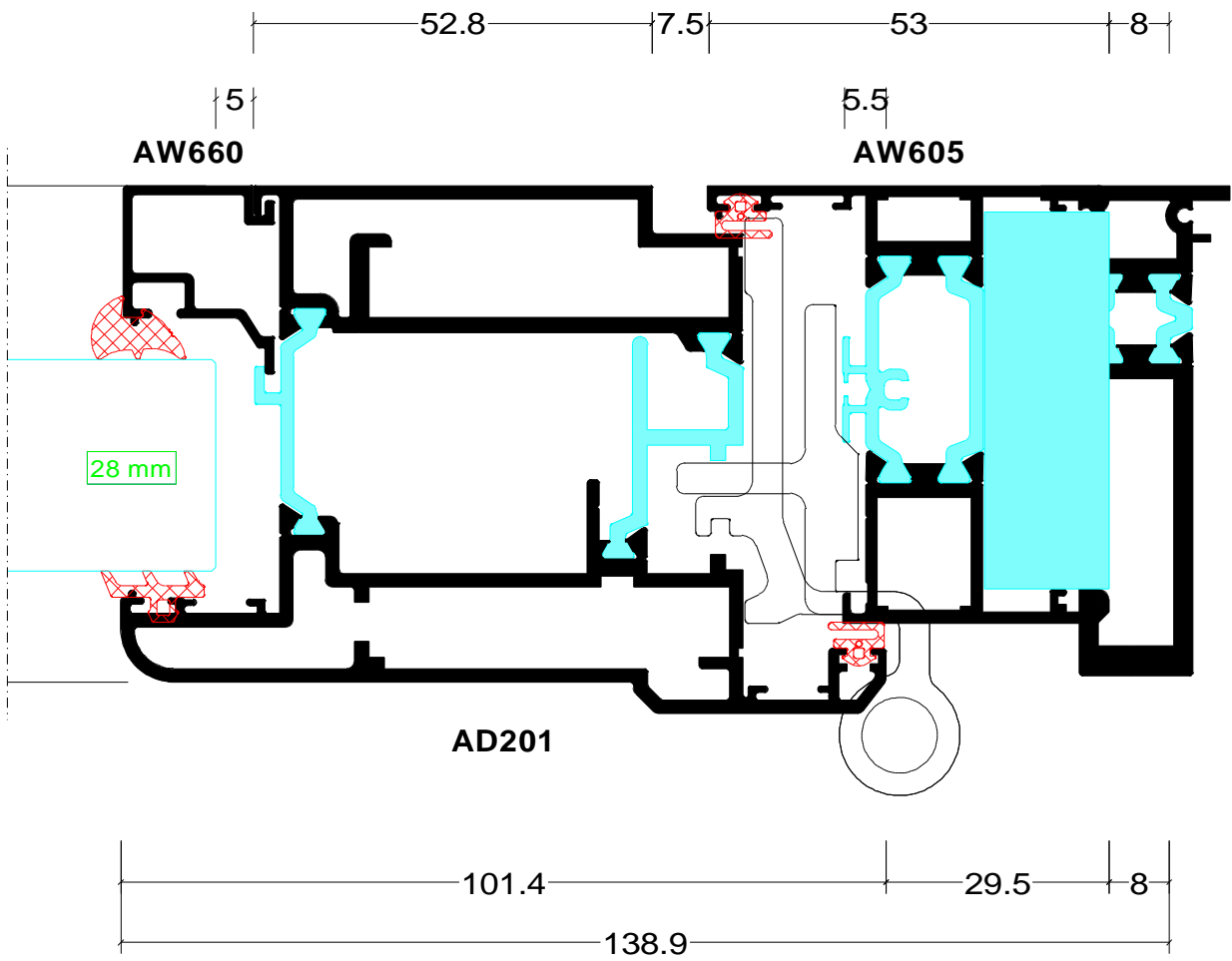

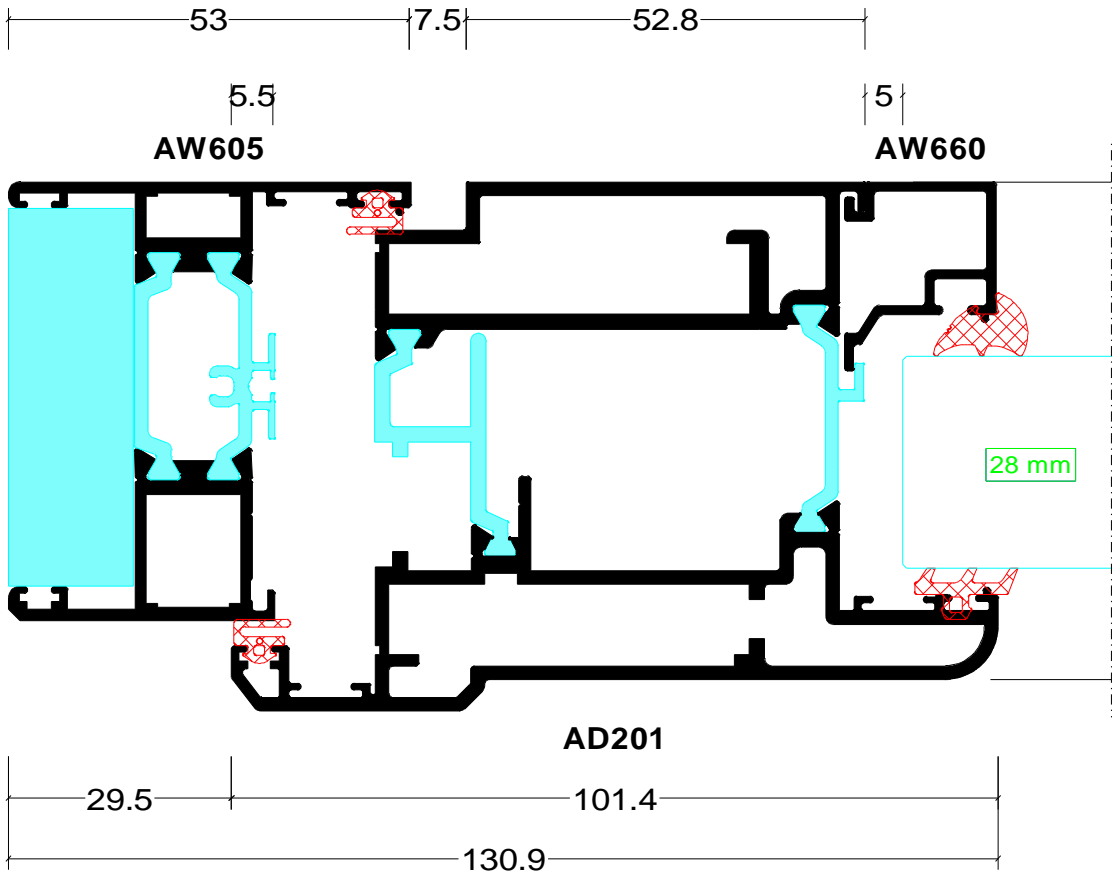

Section 29

Section 30



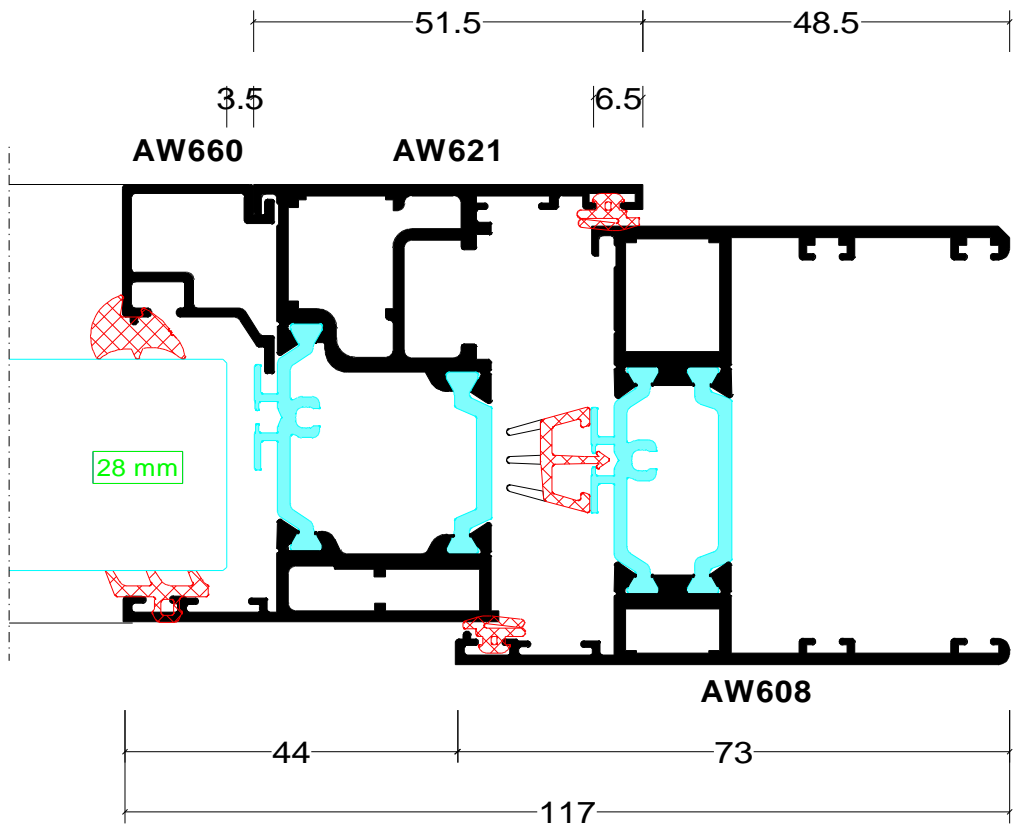

Section 31

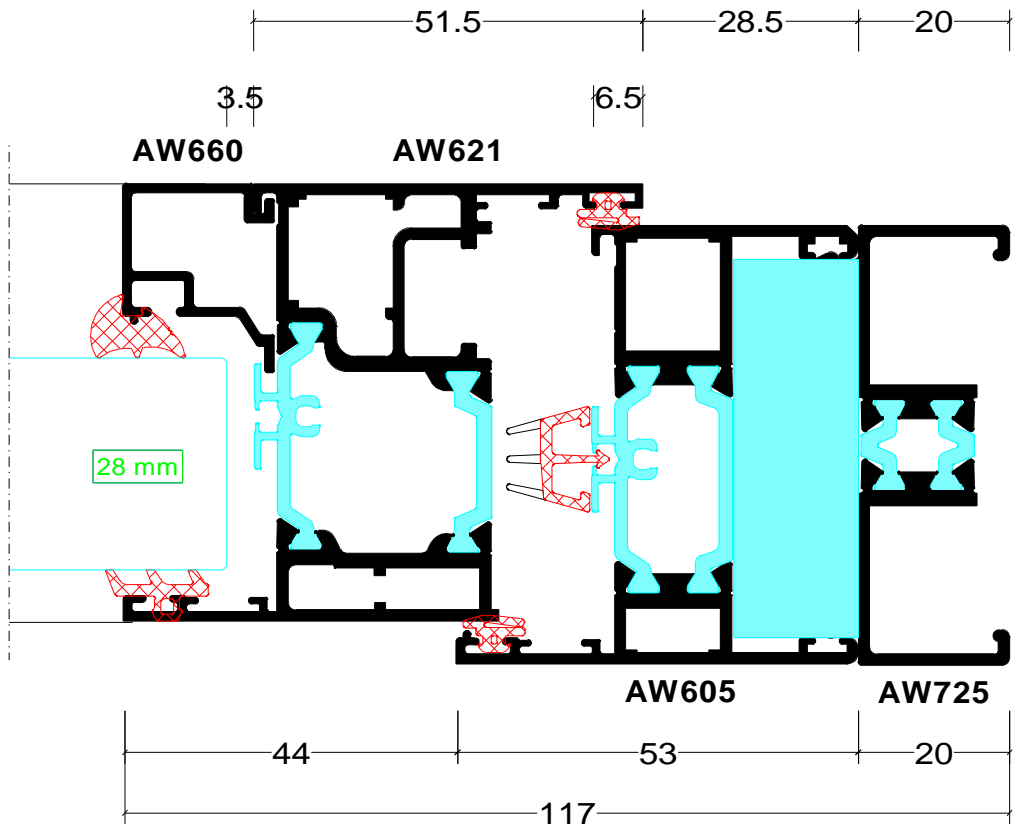

Section 32

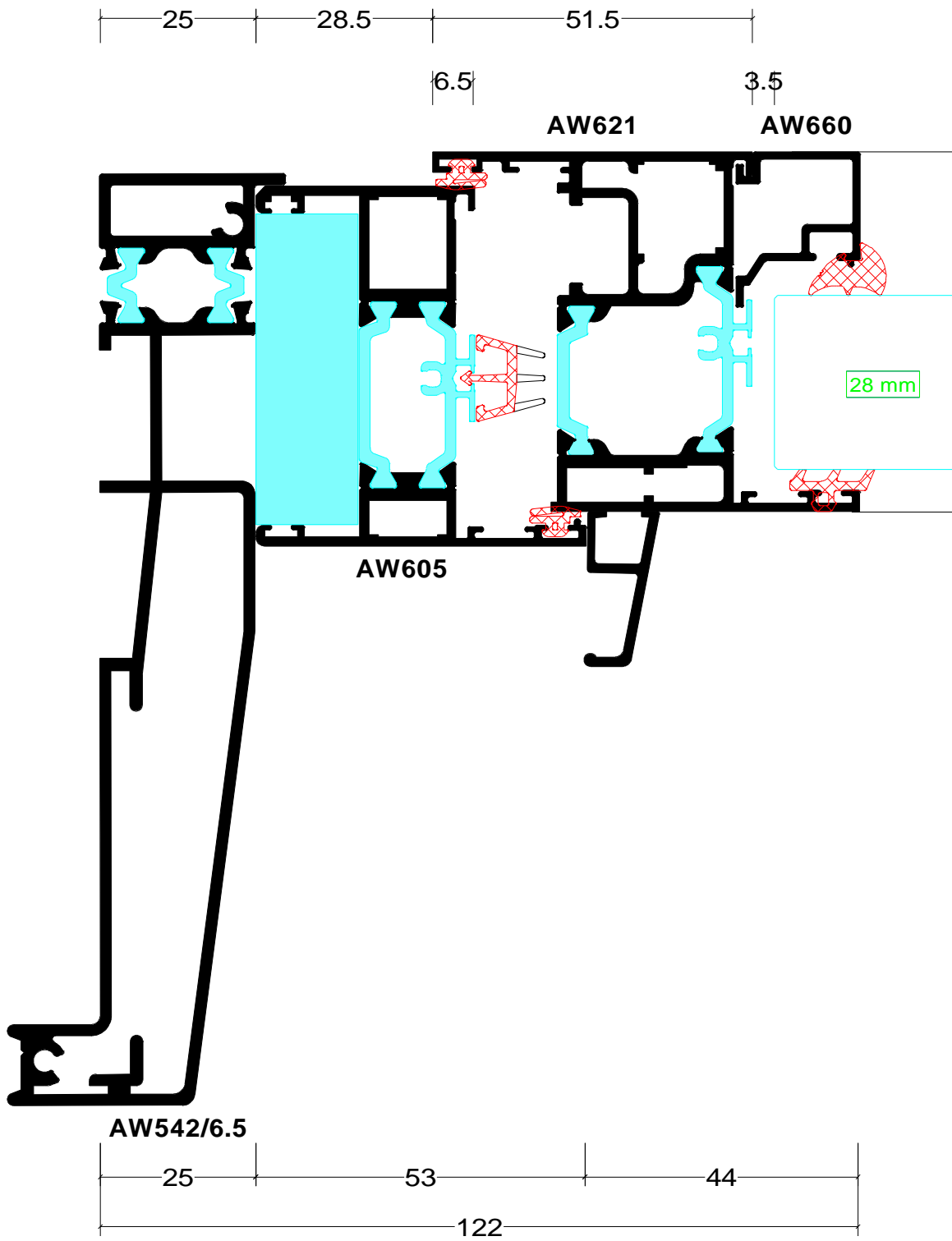

Section 33

Position Drawing Outside

Scale: 1 : 75

Person in Charge: Malc

Page: 1

Date: 19/06/2023

Job: Guardian 182919

Pos: 001

Qty: 1 Scale 1:75

AluK GB 58BW / 58BD Commercial - 58BW OI+58BW Casement (AW620 vent only)

BASE RAL9005M

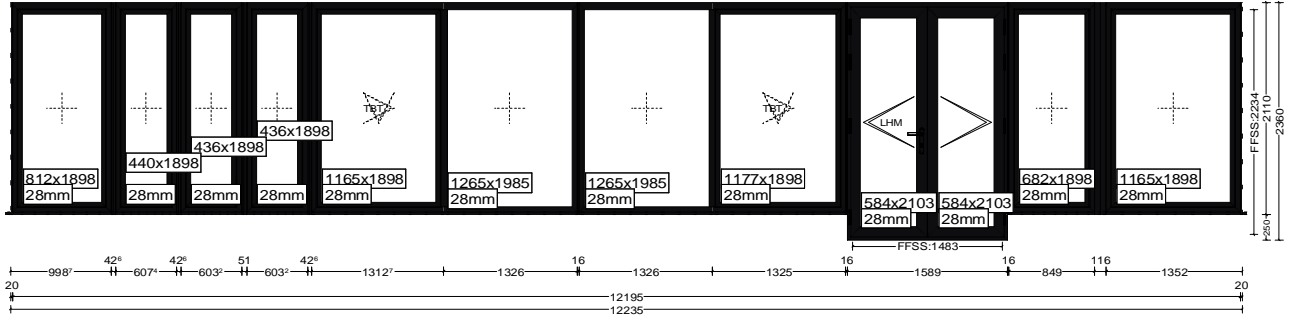

Quantity of Positions: 1

WINDOW WAREHOUSE LIMITED

Customer Details
Guardian Roof UK Limited

Job No: 182919
Ref: Chris London

Date Printed: 19 June 2023 11:08
Delivery/Collection Date: 28 July 2023
Required Week: 29

Bay 1
Baypole Group: @15AW722 Round Pole (70)
Finish: 9005M Deep Black - M

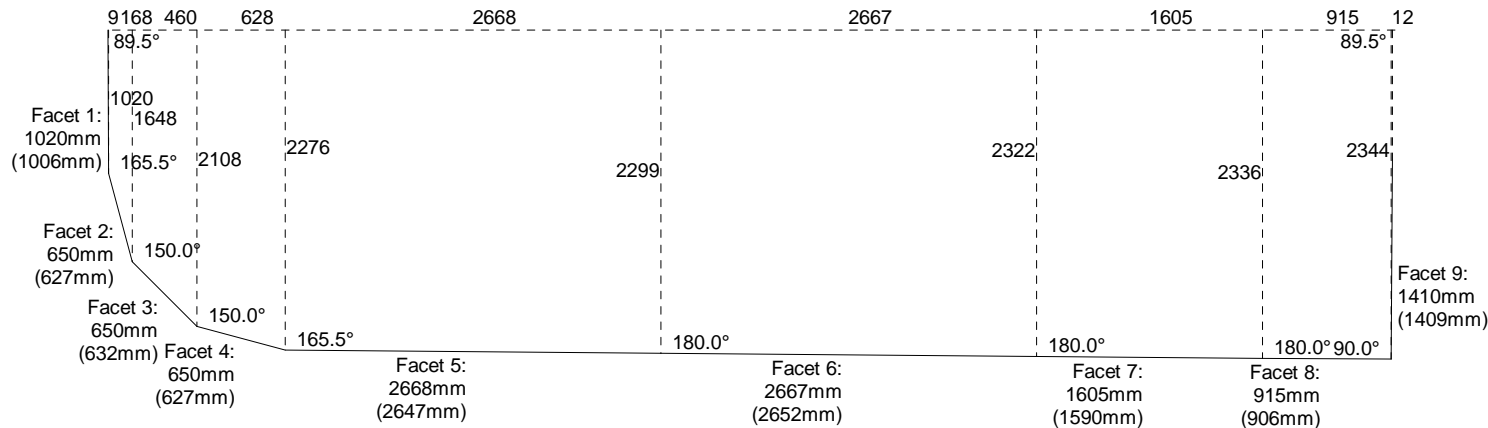

NOTE: All sizes are internal frame or internal cill sizes unless stated otherwise.

Bay Qty Entered: 1
Width: 9179mm (Calculated from other measurements)
Projection: 2344mm
Floor Area: 18.92m²
Volume (exc. roof): 44.6m³

P/Code	Description	Qty	Len1	Len2	Cut/Fit?
AW542r2-5/9005M/65	150mm Drop Nose Cill - 9005M Deep Black - M	1	1070w	1089w	[...]
AW542r2-5/9005M/65	150mm Drop Nose Cill - 9005M Deep Black - M	1	650w	709w	[...]
AW542r2-5/9005M/65	150mm Drop Nose Cill - 9005M Deep Black - M	1	650w	730w	[...]
AW542r2-5/9005M/65	150mm Drop Nose Cill - 9005M Deep Black - M	1	650w	709w	[...]
AW542r2-5/9005M/65	150mm Drop Nose Cill - 9005M Deep Black - M	1	5385w	5404w	[...]
AW542r2-5/9005M/65	150mm Drop Nose Cill - 9005M Deep Black - M	1	1705w		[...]
AW542r2-5/9005M/65	150mm Drop Nose Cill - 9005M Deep Black - M	1	965w	1115w	[...]
AW542r2-5/9005M/65	150mm Drop Nose Cill - 9005M Deep Black - M	1	1460w	1610w	[...]
AW722r2-9005M	70mm Variable Bay Ple 9005M Deep Black - M	4	2085h		[...]
XA946	Bay Cill Assembly RAL	5			[...]
AW703r2-5/9005M	15mm (58) Coupling Bar - 9005M Deep Black - M	3	2085h		[...]
AW721-9005M	90 (58) Corner Post 9005M Deep Black - M	1	2085h		[...]

P/Code	Qty	Size	Description
--------	-----	------	-------------

Cill Sizes (Manufacturing)

FACET / WIN	ANGLE LEFT	ANGLE RIGHT	LENGTH	PCODE	DESCRIPTION
1 / 1	82.8°(7.2°)	TO WALL	1070mm	AW542r2-5/9005M/65	150mm Drop Nose Cill - 9005M Deep Black - M
2 / 1	75.0°(15.0°)	82.8°(7.2°)	650mm	AW542r2-5/9005M/65	150mm Drop Nose Cill - 9005M Deep Black - M
3 / 1	75.0°(15.0°)	75.0°(15.0°)	650mm	AW542r2-5/9005M/65	150mm Drop Nose Cill - 9005M Deep Black - M
4 / 1	82.8°(7.2°)	75.0°(15.0°)	650mm	AW542r2-5/9005M/65	150mm Drop Nose Cill - 9005M Deep Black - M
5-6 / 1 -->1	90.0°(0.0°)	82.8°(7.2°)	5385mm	AW542r2-5/9005M/65	150mm Drop Nose Cill - 9005M Deep Black - M
7 / 1	90.0°(0.0°)	90.0°(0.0°)	1705mm	AW542r2-5/9005M/65	150mm Drop Nose Cill - 9005M Deep Black - M
8 / 1	45.0°(45.0°)	90.0°(0.0°)	965mm	AW542r2-5/9005M/65	150mm Drop Nose Cill - 9005M Deep Black - M
9 / 1	TO WALL	45.0°(45.0°)	1460mm	AW542r2-5/9005M/65	150mm Drop Nose Cill - 9005M Deep Black - M

NOTE: Cill angles are viewed internally.

PLEASE CHECK BAY DETAILS AS ALL WINDOWS AND CILL WILL BE MADE TO THESE DIMENSIONS (WINDOW WAREHOUSE ARE NOT RESPONSIBLE)